







MADISON Three-hole basin mixer with pop-up waste - Brushed Durabronz (23kt Gold)

MADISON

ST 010 107 7370



- 135mm projection
- fixed spout
- circular, air-enriched flow
- height of mixer 72 mm
- height up to aerator 40 mm
- hole diameter valve 32 mm
- hole diameter spout 35 mm
- without rosette
- 2x 1/2" x 1/2" high pressure hose
- max. flow 7 l/min
- lead-free
- This product can help a building meet the requirements of Green Building Rating Systems, e.g. LEED®, BREEAM®, DGNB

	Brushed Durabronz (23kt Gold)	ST 010 107 7370-28
	Chrome	ST 010 107 7370-00
	Brushed Platinum	ST 010 107 7370-06
	Platinum	ST 010 107 7370-08
	Durabronz (23kt Gold)	ST 010 107 7370-09
	Brushed Dark Platinum	ST 010 107 7370-99

Individual components of this set

You need the following components for this set

2x 11 170 370-28



1x 20 700 370-28





MADISON Three-hole basin mixer with pop-up waste - Brushed Durabross
(23kt Gold)

MADISON

ST 010 107 7370

**MADISON Three-hole basin mixer with pop-up waste - Brushed Durabronz
(23kt Gold)**









MADISON

ST 010 107 7370

- for basin fittings

NOTE: Mixers are supplied without lever inserts.
Please order the lever inserts separately!



	Brushed Durabronz (23kt Gold)	11 170 370-28
	Chrome	11 170 370-00
	Gold (23.9kt)	11 170 370-01
	Brushed Platinum	11 170 370-06
	Platinum	11 170 370-08
	Durabronz (23kt Gold)	11 170 370-09
	white	11 170 370-12
	black	11 170 370-13
	Brushed Dark Platinum	11 170 370-99

ST 010 107 7370





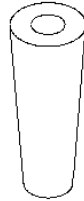



ST 010 107 7370
Parts for other finishes can be found here: Chrome



- 135mm projection
- fixed spout
- circular, air-enriched flow
- height of mixer 72 mm
- height up to aerator 40 mm
- hole diameter valve 32 mm
- hole diameter spout 35 mm
- without rosette
- 2x 1/2" x 1/2" high pressure hose
- max. flow 7 l/min
- lead-free
- This product can help a building meet the requirements of Green Building Rating Systems, e.g. LEED®, BREEAM®, DGNB

Only suitable for basins with an overflow.

	Brushed Durabron (23kt Gold)	20 700 370-28
	Chrome	20 700 370-00
	Brushed Platinum	20 700 370-06
	Platinum	20 700 370-08
	Durabron (23kt Gold)	20 700 370-09
	Brushed Dark Platinum	20 700 370-99



MADISON Three-hole basin mixer with pop-up waste - Brushed Durabrass
(23kt Gold)

MADISON

ST 010 107 7370

ST 010 107 7370
mm [inches]

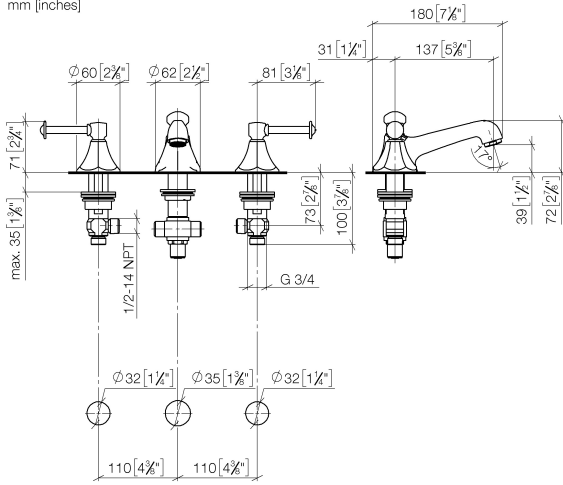

Flow rate chart

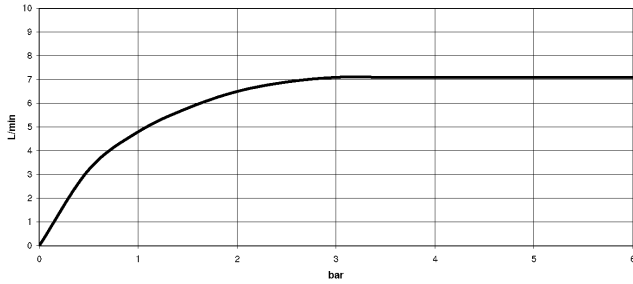

Certificates

GDV_0400288. LGA_8027.

ST 010 107 7370
Parts for other finishes can be found here: Chrome

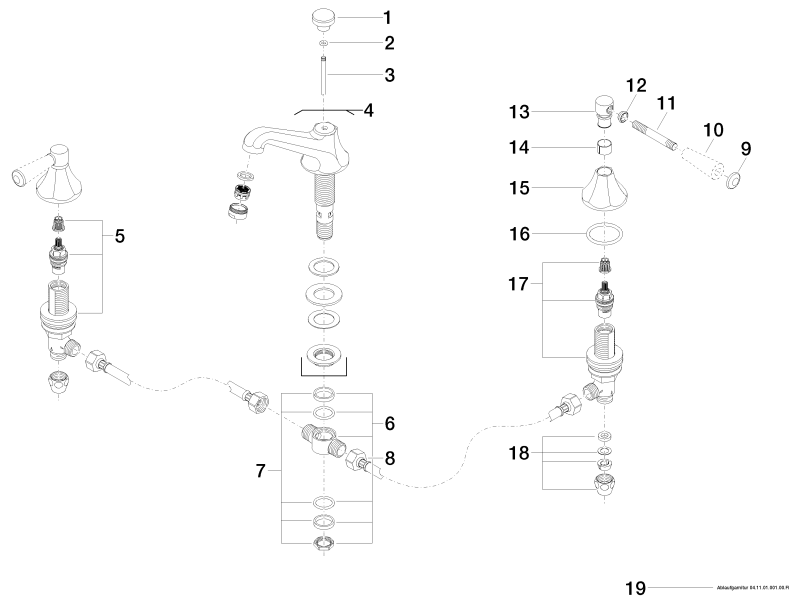

Spare parts list

No.	Item Number	Name	Quantity used	Delivery time
1	09 20 36 030-28	handle	1	20
2	90 14 10 062 00 90	seal	1	2
3	09 31 09 004-28	pull-rod	1	20
4	13 700 380-28	spout	1	-
Spare part can no longer be ordered, please order the replacement item				
5	90 17 11 040 51 90	side panel	1	2
6	90 17 11 020 10 90	distributor	1	2
7	90 23 10 012 00 90	gasket kit	1	2
8	04 30 04 096 00 90	hose	2	2
9	09 30 30 062-28	screw	2	20
10	11 170 370-28	MADISON Lever insert - Brushed Durabron (23kt Gold)	2	20
11	09 28 22 013 90	pipe	2	2
12	09 20 37 001-28	handle	2	20
13	09 20 82 000-28	handle	2	20
14	90 18 40 041 00 90	sleeve	2	2
15	09 27 37 014-28	rosette	2	20
16	90 14 10 043 00 90	seal	2	2
17	90 17 11 040 50 90	side panel	1	2
18	90 23 30 040 00-28	threaded connector	2	20
19	90 11 01 001 00-28	pop-up waste	1	20