







**CYO Three-hole basin mixer with pop-up waste - Durabronss / Brushed
Durabronss (23kt Gold)**

CYO

ST 010 108 2811



- 167mm projection
- fixed spout
- rectangular, air-enriched flow
- height of mixer 198 mm
- height up to aerator 133 mm
- hole diameter spout 35 mm
- hole diameter valve 32 mm
- handle Ø 60mm
- max. flow 4.5 l/min
- lead-free
- with hot / cold marking
- This product can help a building meet the requirements of Green Building Rating Systems, e.g. LEED®, BREEAM®, DGNB

	Durabronss / Brushed Durabronss (23kt Gold)	ST 010 108 2811-38
	Chrome	ST 010 108 2811-00
	Brushed Platinum	ST 010 108 2811-06
	Dark Chrome	ST 010 108 2811-19
	Brushed Durabronss (23kt Gold)	ST 010 108 2811-28
	Platinum / Brushed Platinum	ST 010 108 2811-36
	Brushed Dark Platinum	ST 010 108 2811-99

Individual components of this set

You need the following components for this set

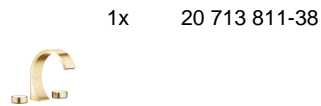
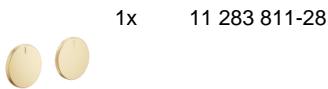



CYO Three-hole basin mixer with pop-up waste - Durabronss / Brushed
Durabronss (23kt Gold)

CYO

ST 010 108 2811

**CYO Three-hole basin mixer with pop-up waste - Durabron / Brushed
Durabron (23kt Gold)**

CYO

ST 010 108 2811



- with hot / cold marking
- for three-hole basin mixers and five-hole bath mixers

	Brushed Durabron (23kt Gold)	11 283 811-28
	Chrome	11 283 811-00
	Brushed Platinum	11 283 811-06
	Platinum	11 283 811-08
	Durabron (23kt Gold)	11 283 811-09
	Dark Chrome	11 283 811-19
	Brushed Champagne (22kt Gold)	11 283 811-46
	Champagne (22kt Gold)	11 283 811-47
	Brushed Dark Platinum	11 283 811-99



CYO Three-hole basin mixer with pop-up waste - Durabronss / Brushed
Durabronss (23kt Gold)

CYO

ST 010 108 2811

ST 010 108 2R11
Parts for other
finishes can be found
here: Chrome

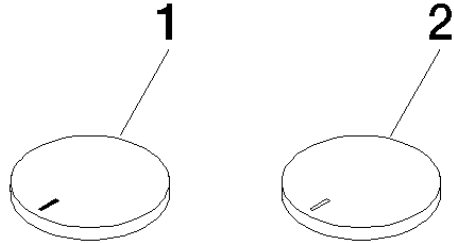

Spare parts list

No.	Item Number	Name	Quantity used	Delivery time
1	11 183 811-28	CYO Handle insert hot - Brushed Durabronss (23kt Gold)	1	20
2	11 184 811-28	CYO Handle insert cold - Brushed Durabronss (23kt Gold)	1	20

**CYO Three-hole basin mixer with pop-up waste - Durabronss / Brushed
Durabronss (23kt Gold)**







CYO

ST 010 108 2811



- 167mm projection
- fixed spout
- rectangular, air-enriched flow
- height of mixer 198 mm
- height up to aerator 133 mm
- hole diameter spout 35 mm
- hole diameter valve 32 mm
- handle Ø 60mm
- max. flow 4.5 l/min
- lead-free
- This product can help a building meet the requirements of Green Building Rating Systems, e.g. LEED®, BREEAM®, DGNB
- WRAS 2111022

NOTE: The handle inserts must be ordered separately from the fittings!

	Durabronss / Brushed Durabronss (23kt Gold)	20 713 811-38
	Chrome	20 713 811-00
	Brushed Platinum	20 713 811-06
	Dark Chrome	20 713 811-19
	Brushed Durabronss (23kt Gold)	20 713 811-28
	Platinum / Brushed Platinum	20 713 811-36
	Brushed Dark Platinum	20 713 811-99



CYO Three-hole basin mixer with pop-up waste - Durabrass / Brushed
Durabrass (23kt Gold)

CYO

ST 010 108 2811

**CYO Three-hole basin mixer with pop-up waste - Durabronss / Brushed
Durabronss (23kt Gold)**

ST 010 108 2R11
mm [inches]

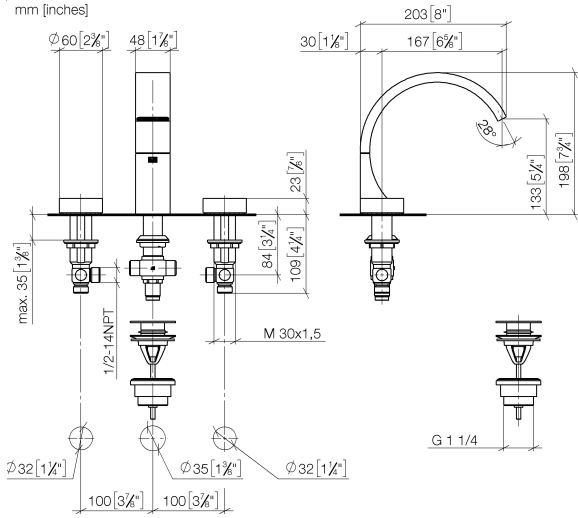

Flow rate chart

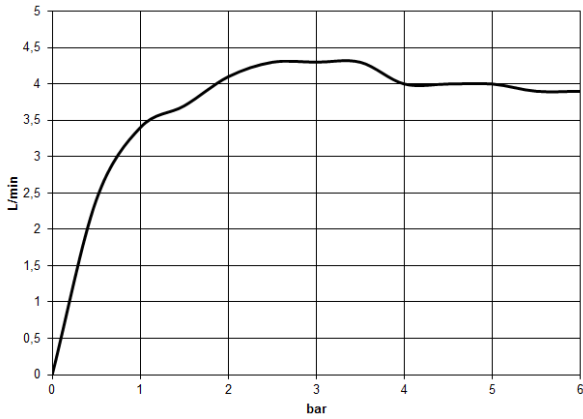

Certificates

WRAS_2111022. LGA_38118.

**CYO Three-hole basin mixer with pop-up waste - Durabronss / Brushed
Durabronss (23kt Gold)**

ST 010 108 2R11
Parts for other
finishes can be found
here: Chrome

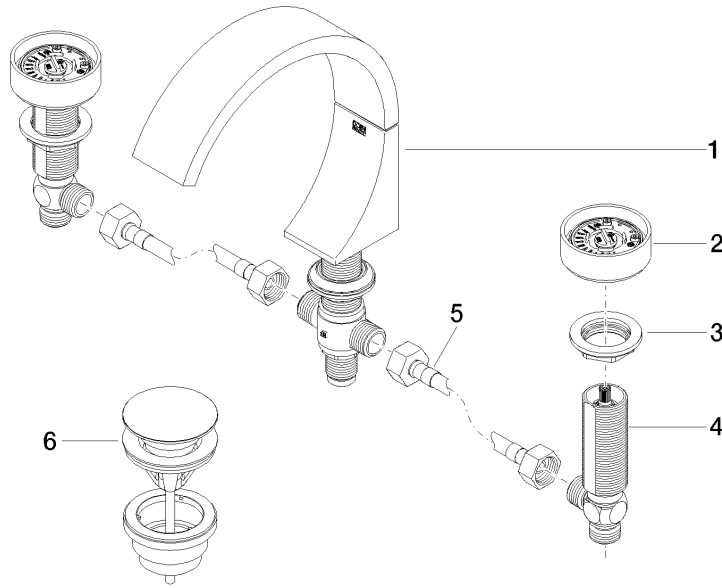

Spare parts list

No.	Item Number	Name	Quantity used	Delivery time
1	13 717 811-38	CYO Deck-mounted basin spout without pop-up waste - Durabronss / Brushed Durabronss (23kt Gold)	1	20
2	90 18 40 290 00-38	handle	2	20
3	04 30 11 038 67 90	fixing set	2	2
4	04 17 11 055 61 90	side panel	2	2
5	04 30 04 096 00 90	hose	2	2
6	10 125 970-38	pop-up waste	1	-

Spare part can no longer be ordered, please order the replacement item