

ST 050 305 2892



- shower with fixed riser projection 452mm
- Rain shower: PURE RAIN, max. flow rate 14 l/min (at 3 bar)
- rain shower Ø 220 mm
- rain shower with anti-scale system
- Hand shower: COMPACT RAIN, max. flow rate 6.8 l/min (at 3 bar)
- spray head Ø 100mm
- rotary diverter with volume control and shut-off function
- slide-on rosettes Ø 70 mm
- height of fittings up to rain shower (bottom edge) 963mm
- height of fittings up to top edge of elbow 1267mm
- gauge 150 mm - 13 mm
- metal shower hose 1750mm with integrated anti-twist protection
- 1/2" connection
- slide bar
- Pipe diameter 23.5 mm

	Champagne (22kt Gold)	ST 050 305 2892-47 0050
	Chrome	ST 050 304 8892-00
	Chrome	ST 050 305 2892-00 0050
	Brushed Platinum	ST 050 304 8892-06
	Brushed Platinum	ST 050 305 2892-06 0050
	Platinum	ST 050 304 8892-08
	Platinum	ST 050 305 2892-08 0050
	Dark Chrome	ST 050 305 2892-19 0050
	Brushed Durabrass (23kt Gold)	ST 050 304 8892-28
	Brushed Durabrass (23kt Gold)	ST 050 305 2892-28 0050
	Matte Black	ST 050 304 8892-33
	Matte Black	ST 050 305 2892-33 0050
	Brushed Champagne (22kt Gold)	ST 050 305 2892-46 0050
	Brushed Chrome	ST 050 305 2892-93 0050
	Brushed Dark Platinum	ST 050 304 8892-99
	Brushed Dark Platinum	ST 050 305 2892-99 0050

Individual components of this set

You need the following components for this set



1x 34 459 892-47 0050



TARA Showerpipe solution 220 mm - Champagne (22kt Gold)

TARA

ST 050 305 2892

ST 050 305 2892

























Fits: TARA, VAIA, META

- shower with fixed riser projection 452mm
- overhead shower: rain flow
- rain shower Ø 220 mm
- rain shower with anti-scale system
- max. rainshower flow 14 l/min
- rotary diverter with volume control and shut-off function
- slide-on rosettes Ø 70 mm
- height of fittings up to rain shower (bottom edge) 963mm
- height of fittings up to top edge of elbow 1267mm
- gauge 150 mm - 13 mm
- metal shower hose 1750mm with integrated anti-twist protection
- 1/2" connection
- slide bar
- Pipe diameter 23.5 mm
- quick clearing
- This product can help a building meet the requirements of Green Building Rating Systems, e.g. LEED®, BREEAM®, DGNB

This article does not include a hand shower!

Intrinsic protection against back flow.

	Champagne (22kt Gold)	34 459 892-47 0050
	Chrome	34 459 892-00
	Chrome	34 459 892-00 0050
	Brushed Platinum	34 459 892-06
	Brushed Platinum	34 459 892-06 0050
	Platinum	34 459 892-08
	Platinum	34 459 892-08 0050
	Dark Chrome	34 459 892-19
	Dark Chrome	34 459 892-19 0050
	Brushed Light Gold	34 459 892-27 0050
	Brushed Light Gold	34 459 892-27
	Brushed Durabronze (23kt Gold)	34 459 892-28
	Brushed Durabronze (23kt Gold)	34 459 892-28 0050
	Matte Black	34 459 892-33
	Matte Black	34 459 892-33 0050
	Brushed Bronze	34 459 892-42
	Brushed Bronze	34 459 892-42 0050
	Brushed Champagne (22kt Gold)	34 459 892-46
	Brushed Champagne (22kt Gold)	34 459 892-46 0050
	Champagne (22kt Gold)	34 459 892-47
	Brushed Chrome	34 459 892-93
	Brushed Chrome	34 459 892-93 0050
	Brushed Dark Platinum	34 459 892-99
	Brushed Dark Platinum	34 459 892-99 0050

ST 050 305 2892

mm [inches]
M 1:10

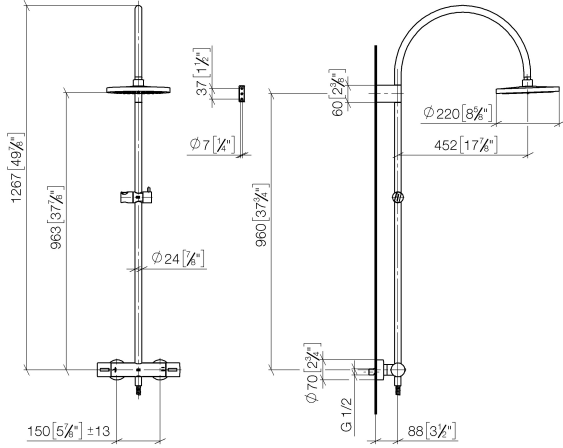

Flow rate chart

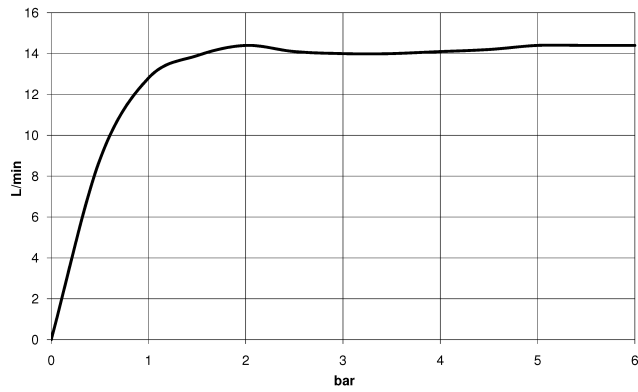

ST 050 305 2892

Parts for other finishes can be found here: [Chrome](#)

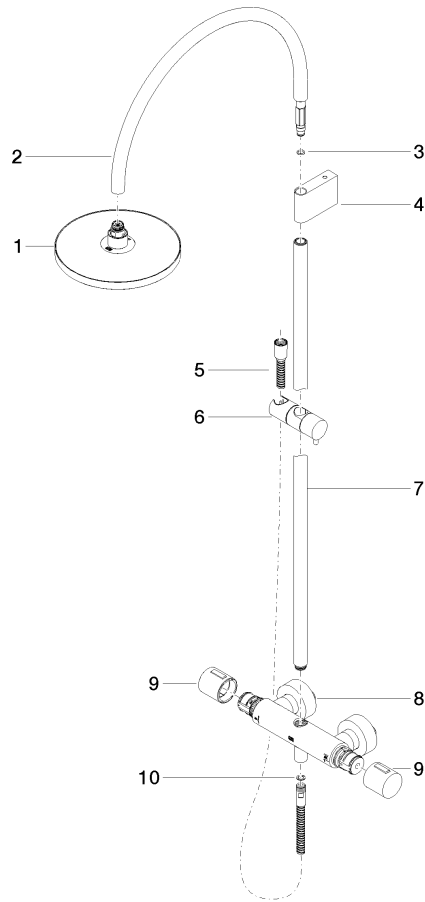

Spare parts list

No.	Item Number	Name	Quantity used	Delivery time
1	90 12 05 092 20-47	shower	1	30
2	04 28 22 346 00-47	pipe	1	60
3	09 14 10 008 90	seal	1	2
4	90 17 11 150 00-47	holder	1	30
5	28 322 970-47	Metal shower hose 1/2" x 3/8" x 1750 mm - Champagne (22kt Gold)	1	30
6	12 570 970-47	Slide unit - Champagne (22kt Gold)	1	30
7	90 28 22 349 00-47	pipe	1	30
8	04 17 01 250 00-47	connection	1	60
9	90 17 33 015 00-47	handle	2	30
10	90 14 20 026 00 90	seal	1	2