

ST 060 108 8780



- cover plate 120 x 120 mm
  - rosette 60 x 60 mm
  - temperature control handle with safety limit stop at 38°C
  - thermostat cartridge
  - head part with cut-to-length spindle and sleeve
- 36 501 985-FF can also be used as an alternative.**

	Brushed Platinum	ST 060 108 8780-06
	Chrome	ST 060 108 8780-00
	Platinum	ST 060 108 8780-08
	Dark Chrome	ST 060 108 8780-19
	Brushed Durabronze (23kt Gold)	ST 060 108 8780-28
	Brushed Champagne (22kt Gold)	ST 060 108 8780-46
	Champagne (22kt Gold)	ST 060 108 8780-47
	Brushed Dark Platinum	ST 060 108 8780-99

**Individual components of this set**

You need the following components for this set



1x 36 501 780-06



1x 36 607 782-06



## MEM xTOOL Thermostat module with 1 valve - Brushed Platinum

---

MEM

ST 060 108 8780

**MEM xTOOL Thermostat module with 1 valve - Brushed Platinum**









MEM

ST 060 108 8780



- cover plate 120 x 120 mm
- temperature control handle with safety limit stop at 38°C
- thermostat cartridge
- WRAS 2011026

Fits: IMO, MEM, CL.1, CYO

	Brushed Platinum	36 501 780-06
	Chrome	36 501 780-00
	Platinum	36 501 780-08
	Dark Chrome	36 501 780-19
	Brushed Light Gold	36 501 780-27
	Brushed Durabronz (23kt Gold)	36 501 780-28
	Matte Black	36 501 780-33
	Brushed Chrome	36 501 780-93
	Brushed Dark Platinum	36 501 780-99

**Required miscellaneous**



**xTOOL Concealed thermostat module without volume control -** 35 503 970 90  
 • max. recess depth 155 mm  
 • min. recess depth 115 mm

**Recommended miscellaneous**



**xGRID Attachment set for integrating in the dry wall construction -** 12 340 970 90

**Required miscellaneous**



**xGRID Installation track 555 mm -** 12 360 970 90

ST 060 108 8780

mm [inches]

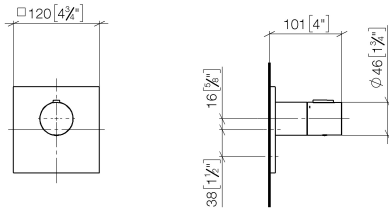

Certificates

WRAS\_2011026.

DVGW\_DW-  
6512DN0706.

LGA\_29930.

LGA\_29932.

ST 060 108 8780

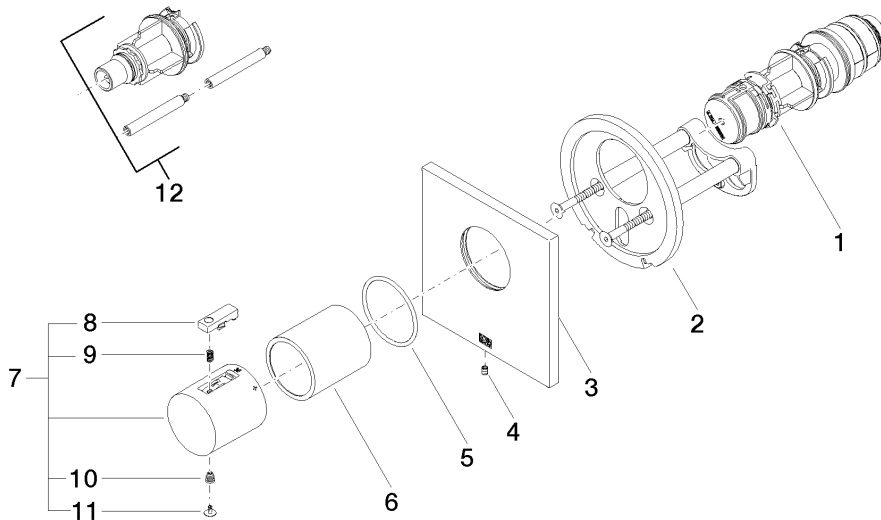

**Spare parts list**

No.	Item Number	Name	Quantity used	Delivery time
1	90 15 05 065 00 90	cartridge	1	2
2	90 11 01 196 00 90	base	1	2
3	90 11 02 533 00-06	cover	1	10
4	09 31 11 044 90	pin	1	2
5	90 14 10 049 00 90	seal	1	2
6	90 21 02 112 00-06	sleeve	1	10
7	90 17 33 004 00-06	handle	1	10
8	90 21 33 011 00-13	handle	1	2
9	90 16 02 027 00 90	spring	1	2
10	90 30 30 136 00 90	screw	1	2
11	90 31 20 049 00-13	plug	1	30
12	12 178 970 90	Extension 46 mm -	1	2

ST 060 108 8780



- rosette 60 x 60 mm
- head part with cut-to-length spindle and sleeve
- WRAS 2011026, 2010066

	Brushed Platinum	36 607 782-06
	Chrome	36 607 782-00
	Platinum	36 607 782-08
	Dark Chrome	36 607 782-19
	Brushed Durabronze (23kt Gold)	36 607 782-28
	Brushed Champagne (22kt Gold)	36 607 782-46
	Champagne (22kt Gold)	36 607 782-47
	Brushed Chrome	36 607 782-93
	Brushed Dark Platinum	36 607 782-99

**Required miscellaneous**



- Wall valve 1/2" -** 35 607 970 90
- max. recess depth 150 mm
  - min. recess depth 105 mm



## MEM xTOOL Thermostat module with 1 valve - Brushed Platinum

---

MEM

ST 060 108 8780

ST 060 108 8780

mm [inches]

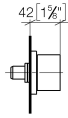
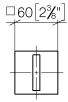

Certificates

DVGW\_DW-  
6501DN0116.

WRAS\_2011026.

IAPMO\_4976 (1).

LGA\_29931.

WRAS\_2010066.

DVGW\_DW-  
6512DN0706.

LGA\_29932.



ST 060 108 8780

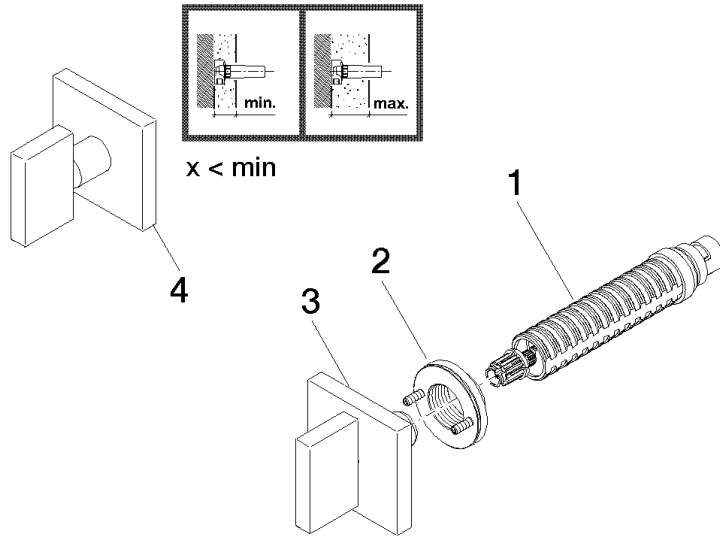

**Spare parts list**

No.	Item Number	Name	Quantity used	Delivery time
1	90 90 03 143 00 90	top	1	2
2	90 21 02 108 00 90	disc	1	2
3	90 20 78 002 02-06	handle	1	10
4	90 20 78 002 01-06	handle	1	10