







ST 110 201 5892



- 235mm projection
- pivotable spout 360°
- air-enriched flow and spray flow
- height of mixer 370 mm
- test
- height up to aerator 212 mm
- hole diameter spout 35 mm
- hole diameter valve 32 mm
- profi spray hole diameter 30mm
- automatic spout/shower diverter
- sprayface with anti-scaling system
- max. flow 7 l/min at 3 bar flow pressure
- lead-free
- This product can help a building meet the requirements of Green Building Rating Systems, e.g. LEED®, BREEAM®, DGNB

	Dark Chrome	ST 110 201 5892-19
	Chrome	ST 110 201 5892-00
	Brushed Platinum	ST 110 201 5892-06
	Platinum	ST 110 201 5892-08
	Brushed Chrome	ST 110 201 5892-93
	Brushed Dark Platinum	ST 110 201 5892-99

Individual components of this set

You need the following components for this set



1x 20 815 892-19



1x 27 789 970-19



TARA Three-hole mixer with profi spray set - Dark Chrome

TARA

ST 110 201 5892

ST 110 201 5892



- 235mm projection
- pivotable spout 360°
- air-enriched flow
- height of mixer 370 mm
- height up to aerator 212 mm
- hole diameter spout 35 mm
- hole diameter valve 32 mm
- max. flow 7 l/min at 3 bar flow pressure
- lead-free
- This product can help a building meet the requirements of Green Building Rating Systems, e.g. LEED®, BREEAM®, DGNB
- WRAS 2107052

	Dark Chrome	20 815 892-19
	Chrome	20 815 892-00
	Brushed Platinum	20 815 892-06
	Platinum	20 815 892-08
	Durabrand (23kt Gold)	20 815 892-09
	Brushed Durabrand (23kt Gold)	20 815 892-28
	Matte Black	20 815 892-33
	Brushed Champagne (22kt Gold)	20 815 892-46
	Champagne (22kt Gold)	20 815 892-47
	Brushed Chrome	20 815 892-93
	Brushed Dark Platinum	20 815 892-99

Recommended miscellaneous

Dispenser with rosette - Dark Chrome 82 444 970-19



Recommended miscellaneous

Strainer waste with control handle - Dark Chrome 10 710 970-19



Recommended miscellaneous

Dispenser with rosette - Dark Chrome 82 444 970-19



ST 110 201 5892

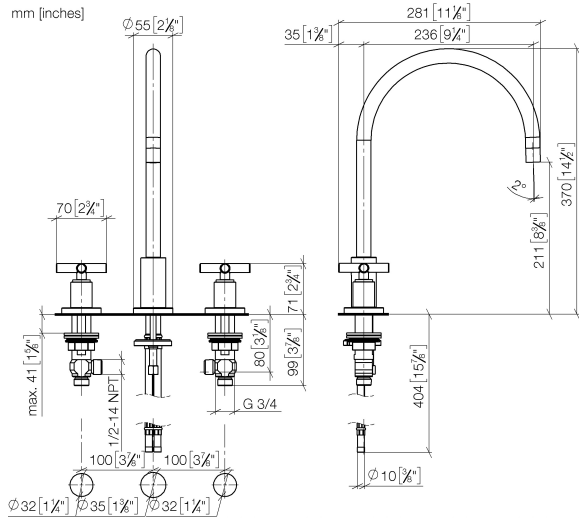

Flow rate chart

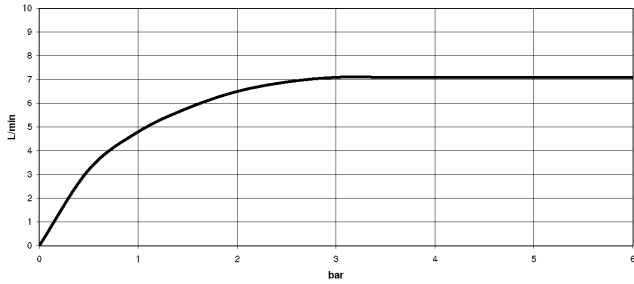

Certificates

GDV_0400289.

ST 110 201 5892

Parts for other finishes can be found here: [Chrome](#)

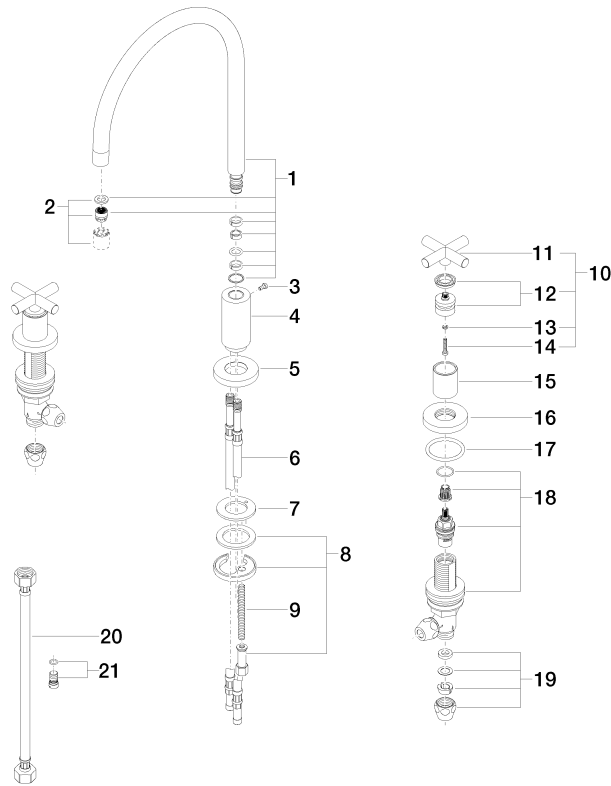







Fits: ELIO, TARA, TARA ULTRA

- spray flow
- automatic diverter for spout/Profi spray set
- height of mixer 665 mm
- individual rosette diameter 55mm
- profi spray hole diameter 30mm
- sprayface with anti-scaling system
- lead-free

Can only be combined with 33826790, 32800790, 33826888, 32815888, 20815892, 33826875.

Intrinsic protection against back flow.

	Dark Chrome	27 789 970-19
	Chrome	27 789 970-00
	Brushed Platinum	27 789 970-06
	Platinum	27 789 970-08
	Brushed Chrome	27 789 970-93
	Brushed Dark Platinum	27 789 970-99



TARA Three-hole mixer with profi spray set - Dark Chrome

TARA

ST 110 201 5892

ST 110 201 5892

mm [inches]
M 1:10

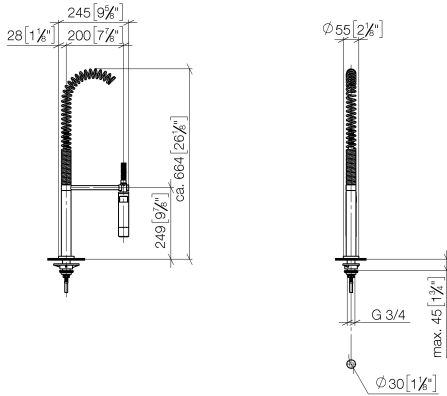

Flow rate chart

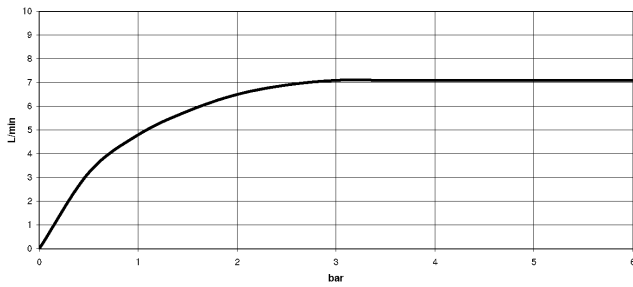

Certificates

LGA_18901. Belgaqua_22_277_2
7_3.

ST 110 201 5892

Parts for other
finishes can be found
here: [Chrome](#)

