







**MEM Bath spout without diverter for free-standing assembly - Brushed Champagne (22kt Gold)**

MEM

13 672 780



- 280mm projection
- cascade
- total height 830 - 900 mm
- height up to aerator 665 – 735 mm
- push-on rosette 130 x 130 mm
- max. flow 47.8 l/min at 3 bar flow pressure

	Brushed Champagne (22kt Gold)	13 672 780-46
	Chrome	13 672 780-00
	Brushed Platinum	13 672 780-06
	Platinum	13 672 780-08
	Dark Chrome	13 672 780-19
	Brushed Durabrass (23kt Gold)	13 672 780-28
	Champagne (22kt Gold)	13 672 780-47

**Required miscellaneous**



- Concealed floor mounting -**
- max. recess depth 150 mm
  - min. recess depth 80 mm

35 945 970 90

**MEM Bath spout without diverter for free-standing assembly - Brushed  
Champagne (22kt Gold)**

MEM

13 672 780  
mm [inches]

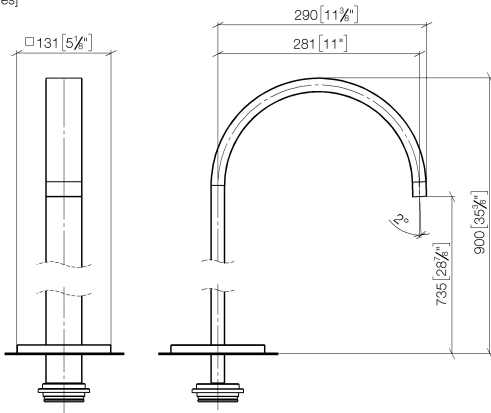

Flow rate chart

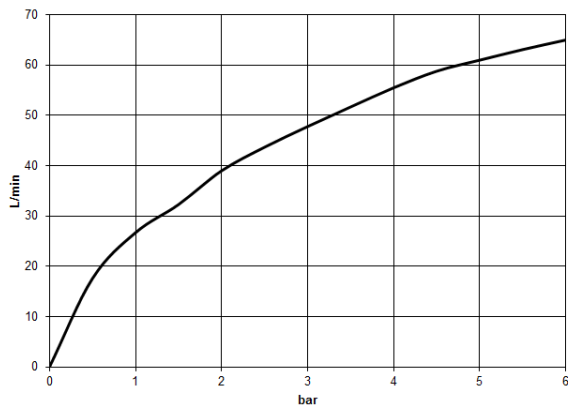

MEM Bath spout without diverter for free-standing assembly - Brushed  
Champagne (22kt Gold)

MEM

13 672 780

