

17 861 888



- 146mm projection
 - rigid, thermally insulated spout
 - laminar flow
 - height of mixer 288 mm
 - height up to laminar flow regulator 180 mm
 - hole diameter 35 mm
 - provides filtered, hot water up to 93°C
 - provides filtered, cold water
 - max. flow 2 l/min at 3 bar flow pressure
 - ready-to-use control unit for wall mounting (137mm x 159mm x 60mm)
 - electronic magnetic valve
 - 100-230 V, 50-60 Hz, 18 W power supply unit, incl. country-specific adapter set
 - lead-free
 - Spout ring cannot be removed.
 - This product can help a building meet the requirements of Green Building Rating Systems, e.g. LEED®, BREEAM®, DGNB
- A minimum flow pressure of 3 bar is necessary for the HOT & COLD WATER DISPENSER to work perfectly in conjunction with a hot water tank and filter.**
- In addition, the installation must be above a kitchen sink.**
- The filter cartridge must be changed every six months. The installation instructions contain further information for guidance.**
- Detailed planning information and technical data can be found at www.dornbracht.com/professional**

A minimum flow pressure of 3 bar is necessary for the HOT & COLD WATER DISPENSER to work perfectly in conjunction with a hot water tank and filter.

In addition, the installation must be above a kitchen sink.

The filter cartridge must be changed every six months. The installation instructions contain further information for guidance.

Detailed planning information and technical data can be found at www.dornbracht.com/professional

	Brushed Durabronz (23kt Gold)	17 861 888-28
	Chrome	17 861 888-00
	Brushed Platinum	17 861 888-06
	Platinum	17 861 888-08
	Durabronz (23kt Gold)	17 861 888-09
	Dark Chrome	17 861 888-19
	Matte Black	17 861 888-33
	Brushed Champagne (22kt Gold)	17 861 888-46
	Champagne (22kt Gold)	17 861 888-47
	Brushed Chrome	17 861 888-93
	Brushed Dark Platinum	17 861 888-99

Required miscellaneous



Hot water tank incl. filter - 12 892 970 90

17 861 888

mm [inches]

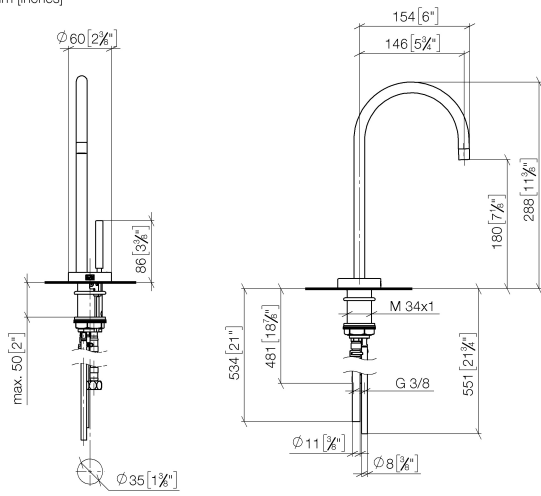

Flow rate chart

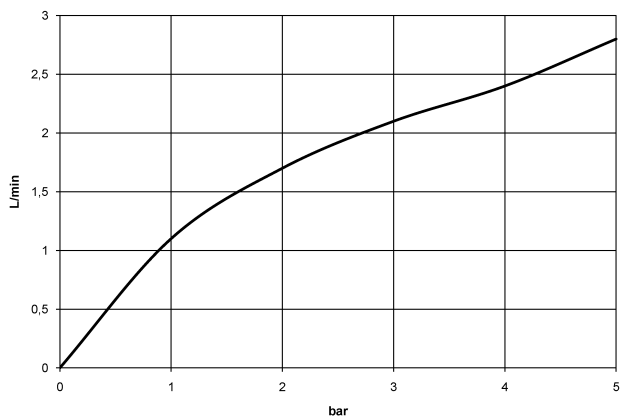

Certificates

IAPMO_N-4976.

GDV_0400297.

LGA_28297.

IAPMO_6397.

17 861 888



Spare parts list

No.	Item Number	Name	Quantity used	Delivery time
1	90 17 85 100 06-28	fitting	1	20
2	90 30 04 067 00 90	hose	1	2
3	90 10 01 048 00 90	electronic accessories	1	2
4	04 10 01 050 00 90	power supply	1	60
5	12 866 970 90	adaptor	1	2
6	90 11 11 064 01 90	electronic accessories	1	2
7	90 24 04 291 00 90	insert	1	2
8	09 24 04 293 90	nipple	1	2
9	09 16 01 045 90	ring	1	2