







CL.1 Deck valve anti-clockwise closing hot - Brushed Platinum

CL.1

20 004 706



- hole diameter 32 mm
- rosette 60 x 47 mm
- with hot marking
- WRAS 240202020

	Brushed Platinum	20 004 706-06
	Chrome	20 004 706-00
	Dark Chrome	20 004 706-19
	Brushed Champagne (22kt Gold)	20 004 706-46
	Champagne (22kt Gold)	20 004 706-47
	Brushed Dark Platinum	20 004 706-99

20 004 706

mm [inches]

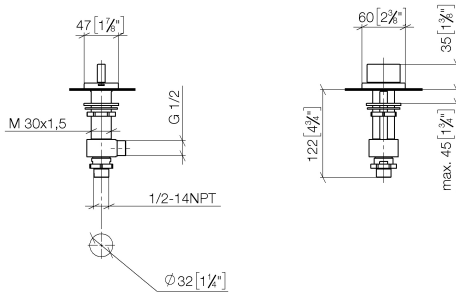

Flow rate chart

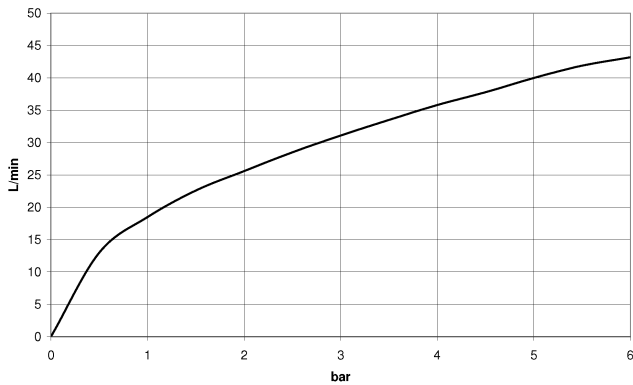

Codes & Standards

ASME A112.18.1	cUPC	DIN 4109	ISO 3822
NSF372	NSF61	Scottish Water Byelaws	UK Water Supply Regulations

Ü-Zeichen



CL.1 Deck valve anti-clockwise closing hot - Brushed Platinum

CL.1

20 004 706

Certificates

WRAS_240202

IAPMO_4976

IAPMO_N-4

WRAS_1804

LGA_28

IAPMO_6

20 004 706

Product version from 3/9/2015

Parts for other finishes can be found here: [Chrome](#)

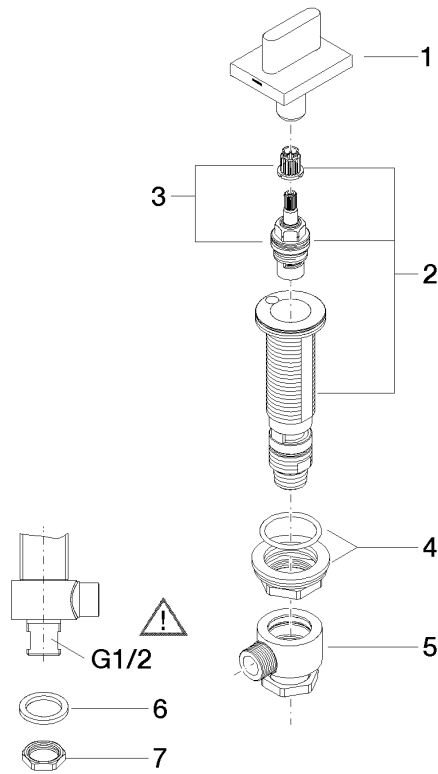



CL.1 Deck valve anti-clockwise closing hot - Brushed Platinum

CL.1

20 004 706

Spare parts list

Product version from 3/9/2015

No.	Item Number	Name	Quantity used	Delivery time
	90 20 70 051 07-06	handle (hot)	8	10