













26 413 625



Fits: TARA, META

- slide bar
- Pipe diameter 18 mm
- rosette Ø 55 mm
- gauge 800 mm
- metal shower hose 1750mm with integrated anti-twist protection
- shower hose connector 3/8"
- WRAS 2009048

This article does not include a hand shower!

| | | |
|--|-------------------------------------|---------------|
|  | Brushed Platinum | 26 413 625-06 |
|  | Chrome | 26 413 625-00 |
|  | Platinum | 26 413 625-08 |
|  | Dark Chrome | 26 413 625-19 |
|  | Light Gold | 26 413 625-26 |
|  | Brushed Light Gold | 26 413 625-27 |
|  | Brushed Durabronze (23kt Gold) | 26 413 625-28 |
|  | Matte Black | 26 413 625-33 |
|  | Brushed Bronze | 26 413 625-42 |
|  | Brushed Champagne (22kt Gold) | 26 413 625-46 |
|  | Champagne (22kt Gold) | 26 413 625-47 |
|  | Brushed Chrome | 26 413 625-93 |
|  | Brushed Dark Platinum | 26 413 625-99 |

26 413 625

Recommended miscellaneous

| | | |
|---|--|---------------|
|  | Concealed wall elbow - •max. recess depth 163 mm •min. recess depth 90 mm | 35 085 970 90 |
|---|--|---------------|

Required miscellaneous

| | | |
|---|---------------------------------------|---------------|
|  | Hand shower - Brushed Platinum | 28 012 979-06 |
|---|---------------------------------------|---------------|

Required miscellaneous

| | | |
|---|---------------------------------------|---------------|
|  | Hand shower - Brushed Platinum | 28 017 979-06 |
|---|---------------------------------------|---------------|

Required miscellaneous

| | | |
|---|---------------------------------------|---------------|
|  | Hand shower - Brushed Platinum | 28 016 979-06 |
|---|---------------------------------------|---------------|

Required miscellaneous

| | | |
|---|--|-----------------------|
|  | Hand shower FlowReduce - Brushed Platinum | 28 018 979-06 0010 |
|---|--|-----------------------|

Required miscellaneous

| | | |
|---|--|---------------|
|  | SERIES-VARIOUS Hand shower - Brushed Platinum | 28 029 979-06 |
|---|--|---------------|

Required miscellaneous

| | | |
|---|--|-----------------------|
|  | SERIES-VARIOUS Hand shower - Brushed Platinum | 28 025 979-06 0010 |
|---|--|-----------------------|

Recommended miscellaneous

| | | |
|---|--------------------------------------|---------------|
|  | Wall elbow - Brushed Platinum | 28 450 625-06 |
|---|--------------------------------------|---------------|

Required miscellaneous

| | | |
|---|--|-----------------------|
|  | Hand shower FlowReduce - Brushed Platinum | 28 016 979-06 0010 |
|---|--|-----------------------|

Required miscellaneous

| | | |
|---|--|-----------------------|
|  | Hand shower FlowReduce - Brushed Platinum | 28 012 979-06 0010 |
|---|--|-----------------------|

Required miscellaneous

| | | |
|---|---------------------------------------|---------------|
|  | Hand shower - Brushed Platinum | 28 018 979-06 |
|---|---------------------------------------|---------------|

Required miscellaneous

| | | |
|---|--|-----------------------|
|  | SERIES-VARIOUS Hand shower - Brushed Platinum | 28 029 979-06 0010 |
|---|--|-----------------------|

Required miscellaneous

| | | |
|---|--|-----------------------|
|  | SERIES-VARIOUS Hand shower - Brushed Platinum | 28 027 979-06 0010 |
|---|--|-----------------------|

26 413 625

mm [inches]

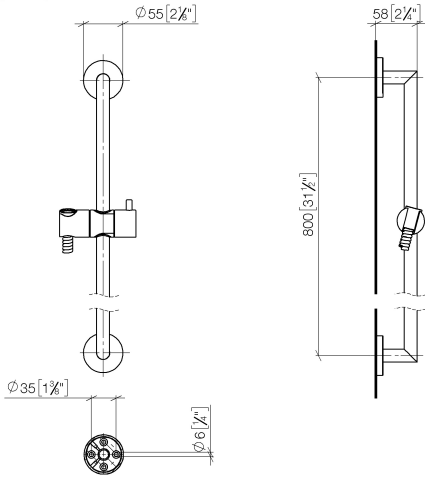

Codes & Standards

ASME A112.18.1

cUPC

Scottish Water
Byelaws

UK Water Supply
Regulations

XP P 41-280

Certificates

IAPMO_4976

WRAS_2009

ACS_20 ACC LY

26 413 625

Product version from 10/1/2023

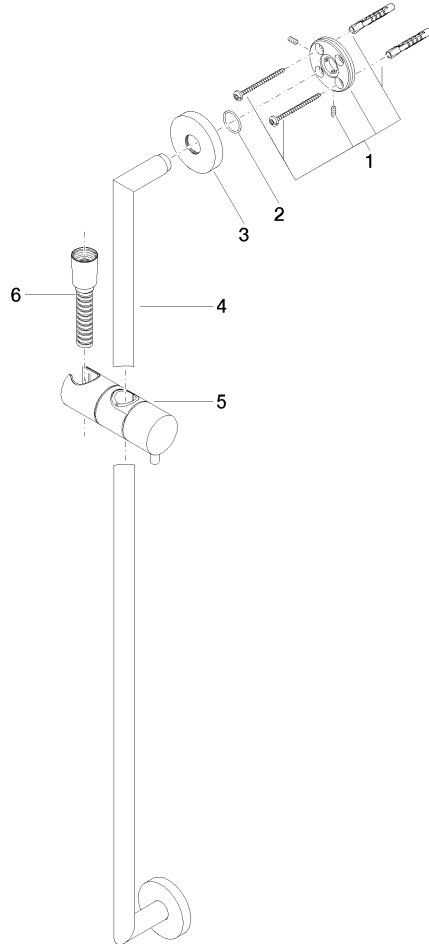



Shower set without hand shower - Brushed Platinum

TARA

26 413 625

Spare parts list

Product version from 10/1/2023

| No. | Item Number | Name | Quantity used | Delivery time |
|-----|--------------------|------------|---------------|---------------|
| | 05 17 62 500 00 90 | fixing set | 9 | 2 |