

# MEM Bath shower set for bath rim or tile edge installation - Dark Chrome

MEM

27 532 782



- 220mm projection
- spout: rectangular normal flow
- max. flow 27.3 l/min at 3 bar flow pressure
- Hand shower: COMPACT RAIN, max. flow rate 6.8 l/min (at 3 bar)
- complete hand shower set with anti-scale system
- automatic bath/shower diverter
- height of mixer 300 mm
- height up to aerator 170 mm
- hole diameter valve 32 mm
- hole diameter spout 32 mm
- hole diameter for complete hand shower set 32 mm
- rosette for spout 60 x 60mm
- rosette for complete hand shower set 60 x 60mm
- rosette for deck valve 60 x 60mm
- metal shower hose 1750mm with integrated anti-twist protection
- WRAS 2306058

Intrinsic protection against back flow.

	Dark Chrome	27 532 782-19
	Chrome	27 532 782-00
	Brushed Platinum	27 532 782-06
	Platinum	27 532 782-08
	Brushed Durabronze (23kt Gold)	27 532 782-28
	Brushed Champagne (22kt Gold)	27 532 782-46
	Champagne (22kt Gold)	27 532 782-47
	Brushed Dark Platinum	27 532 782-99

## Recommended miscellaneous



**Perfecto installation kit -** 12 614 970 90

## Recommended miscellaneous



**Decorative caps for Perfecto - Dark Chrome** 12 801 970-19  
• 1 pair

27 532 782

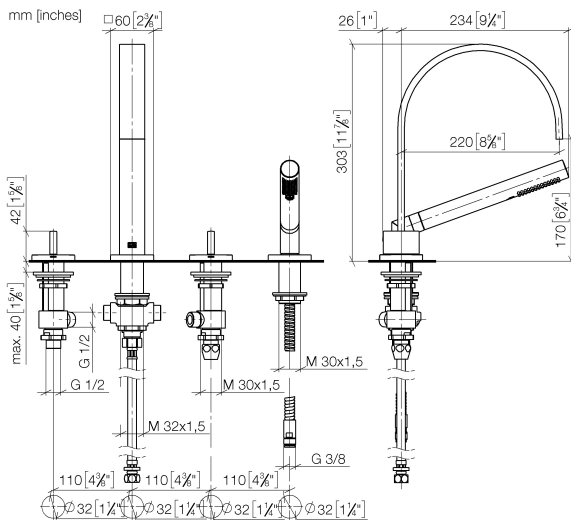

Flow rate chart

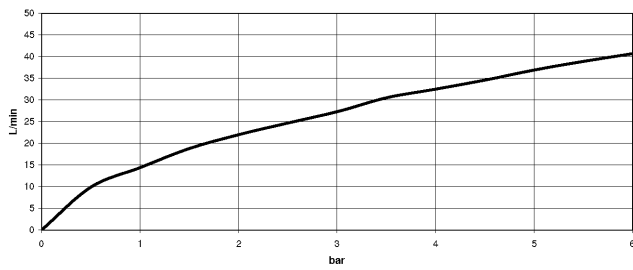

Certificates

WRAS\_2306058.

27 532 782

