

Rain shower with wall fixing 300 mm - Brushed Champagne (22kt Gold)













TARA

28 679 970



- 450mm projection
- rain shower Ø 300 mm
- PURE RAIN, max. flow rate 14 l/min (at 3 bar)
- Function from: 10 l/min
- rosette Ø 60 mm
- 1/2" connection
- with anti-scale system
- quick clearing
- WRAS 2212012

Fits: TARA, LISSÉ, VAIA, META

	Brushed Champagne (22kt Gold)	28 679 970-46
	Chrome	28 679 970-00
	Brushed Platinum	28 679 970-06
	Platinum	28 679 970-08
	Dark Chrome	28 679 970-19
	Light Gold	28 679 970-26
	Brushed Light Gold	28 679 970-27
	Brushed Durabrass (23kt Gold)	28 679 970-28
	Matte Black	28 679 970-33
	Brushed Bronze	28 679 970-42
	Champagne (22kt Gold)	28 679 970-47
	Brushed Chrome	28 679 970-93
	Brushed Dark Platinum	28 679 970-99

Recommended miscellaneous



- Concealed wall elbow -** 35 085 970 90
- max. recess depth 163 mm
 - min. recess depth 90 mm

28 679 970

mm [inches]



Flow rate chart



Certificates

WRAS_2212012. DVGW_DW- LGA_29235.
6517DN0118.

28 679 970

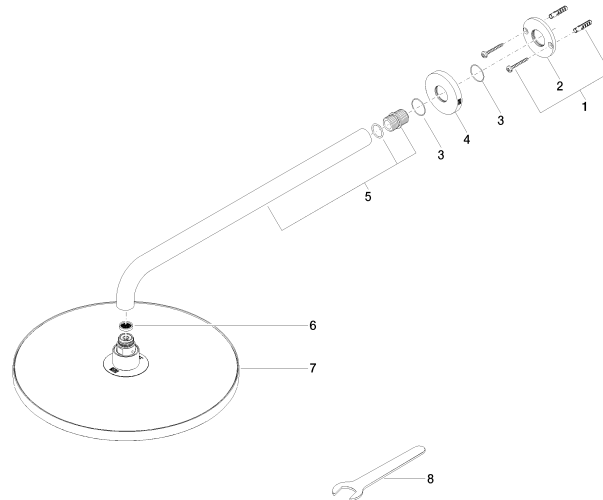

Spare parts list

No.	Item Number	Name	Quantity used	Delivery time
1	04 30 31 032 00 90	fixing set	1	2
2	09 17 20 120 90	holder	1	2
3	09 14 10 150 90	seal	2	2
4	09 27 97 015-46	rosette	1	30
5	90 11 03 070 00-46	pipe	1	30
6	09 23 01 075 90	insert	1	2
7	04 12 05 091 00-46	shower	1	30
8	90 30 09 069 00 90	key	1	2