

LISSÉ Single-lever bath mixer for wall mounting without shower set - Dark Chrome







LISSÉ

33 200 845



- 190-200mm projection
- circular normal flow
- automatic bath/shower diverter
- 3/8" shower outlet
- slide-on rosettes Ø 60 mm
- 1/2" connection
- gauge 150 mm - 15 mm
- max. flow 13.5 l/min at 3 bar flow pressure

Intrinsic protection against back flow.

	Dark Chrome	33 200 845-19
	Chrome	33 200 845-00
	Brushed Platinum	33 200 845-06
	Matte Black	33 200 845-33
	Brushed Chrome	33 200 845-93
	Brushed Dark Platinum	33 200 845-99

33 200 845

mm [inches]

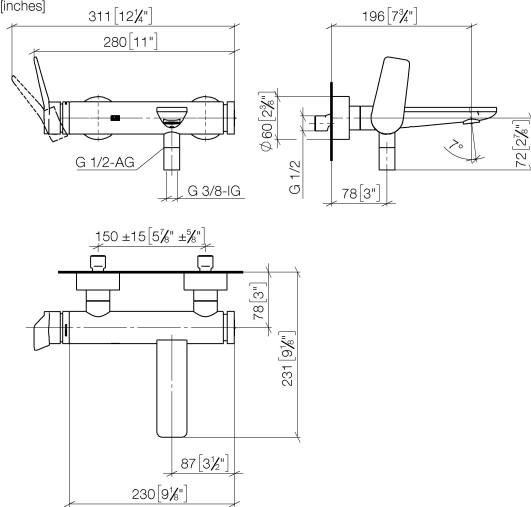

Flow rate chart

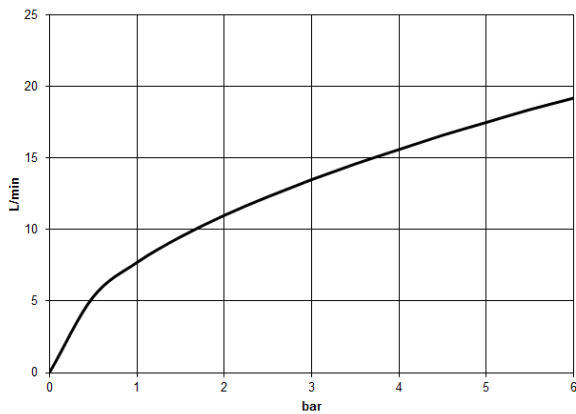

Certificates

LGA_9603.

WRAS_2311042.

**LISSÉ Single-lever bath mixer for wall mounting without shower set - Dark
Chrome**

LISSÉ

33 200 845

Parts for other
finishes can be found
here: [Chrome](#)

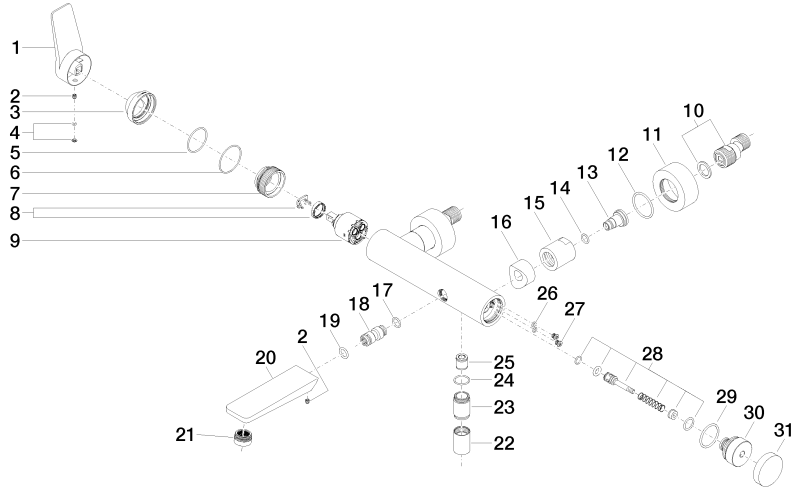



LISSÉ Single-lever bath mixer for wall mounting without shower set - Dark Chrome

LISSÉ

33 200 845

Spare parts list

No.	Item Number	Name	Quantity used	Delivery time
1	09 20 84 021-19	handle	1	60
2	90 31 11 030 00 90	pin	2	2
3	09 28 30 032-19	cover	1	20
4	90 31 20 087 00-19	plug	1	20
5	09 14 10 102 90	seal	1	2
6	09 14 10 190 90	seal	1	2
7	09 24 04 296 90	nut	1	2
8	90 28 10 148 00 90	accessories	1	2
9	90 15 05 064 00 90	cartridge	1	2
10	04 11 04 030 00 90	connection	2	2
11	09 27 62 004-19	rosette	2	20
12	09 14 10 119 90	seal	2	2
13	09 29 05 005 20-19	nipple	2	20
14	09 14 10 008 90	seal	2	2
15	09 23 10 048-19	nut	2	20
16	09 18 40 059-19	sleeve	2	20
17	09 14 10 003 90	seal	1	2
18	09 24 04 043 90	nipple	1	2
19	90 14 10 011 00 90	seal	1	2
20	09 11 84 012-19	spout	1	60
21	90 23 01 161 00-19	aerator	1	20
22	90 21 02 069 00-19	cover	1	20
23	09 24 03 115 20-19	nipple	1	20
24	90 14 10 032 00 90	seal	1	2
25	90 23 01 141 00 90	back-flow preventer	1	2
26	09 14 10 001 90	seal	2	2
27	09 30 30 113 20 90	screw	2	2
28	90 31 09 032 00-19	diverter	1	20
29	09 14 10 101 90	seal	1	2
30	09 21 10 035 20-19	nipple	1	20
31	09 20 62 031-19	handle	1	20