

TARA Single-lever mixer for rinsing/Profi spray - Matte Black

33 826 888



- 235mm projection
- pivotable spout 360°
- air-enriched flow
- height of mixer 400 mm
- height up to aerator 230 mm
- single-lever mixer hole diameter 35mm
- max. flow 7 l/min at 3 bar flow pressure
- lead-free
- WRAS 1705020
- This product can help a building meet the requirements of Green Building Rating Systems, e.g. LEED®, BREEAM®, DGNB

Single-lever mixer for combining with rinsing/Profi spray only

	Matte Black	33 826 888-33
	Chrome	33 826 888-00
	Brushed Platinum	33 826 888-06
	Platinum	33 826 888-08
	Durabrand (23kt Gold)	33 826 888-09
	Dark Chrome	33 826 888-19
	Brushed Durabrand (23kt Gold)	33 826 888-28
	Brushed Champagne (22kt Gold)	33 826 888-46
	Champagne (22kt Gold)	33 826 888-47
	Brushed Chrome	33 826 888-93
	Brushed Dark Platinum	33 826 888-99

Recommended miscellaneous



Rinsing spray set - Matte Black 27 721 970-33

TARA Single-lever mixer for rinsing/Profi spray - Matte Black

33 826 888

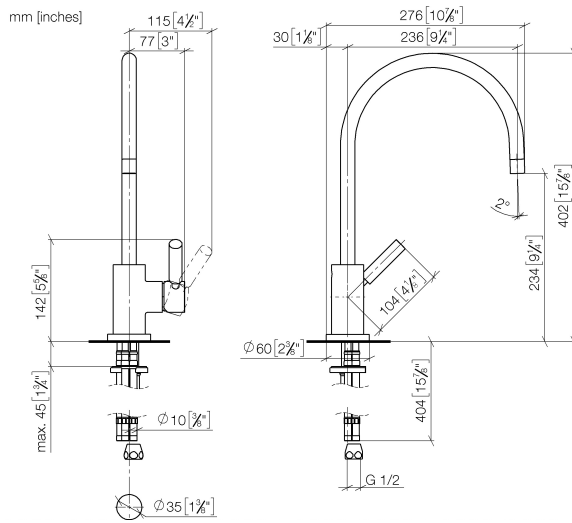

Flow rate chart

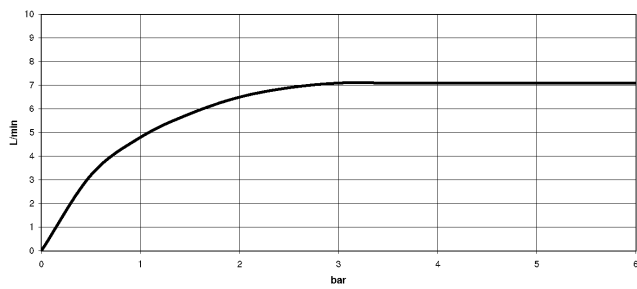

Certificates

LGA_18901.

ETA_18524.

WRAS_2311044.

TARA Single-lever mixer for rinsing/Profi spray - Matte Black

33 826 888

Parts for other
finishes can be found
here: [Chrome](#)

