







33 845 875



- 552mm projection
- pivotable spout 360°
- air-enriched flow
- height of mixer 372 mm
- height up to aerator 290 mm
- rosette 55 mm
- hole diameter 30 mm
- max. flow 8 l/min at 3 bar flow pressure
- lead-free
- This product can help a building meet the requirements of Green Building Rating Systems, e.g. LEED®, BREEAM®, DGNB

	Brushed Champagne (22kt Gold)	33 845 875-46
	Chrome	33 845 875-00
	Brushed Platinum	33 845 875-06
	Platinum	33 845 875-08
	Durabross (23kt Gold)	33 845 875-09
	Dark Chrome	33 845 875-19
	Brushed Durabross (23kt Gold)	33 845 875-28
	Champagne (22kt Gold)	33 845 875-47
	Brushed Chrome	33 845 875-93
	Brushed Dark Platinum	33 845 875-99

**Recommended miscellaneous**

**Dispenser with rosette - Brushed Champagne (22kt Gold)** 82 444 970-46



**Recommended miscellaneous**

**Strainer waste with control handle - Brushed Champagne (22kt Gold)** 10 710 970-46



33 845 875

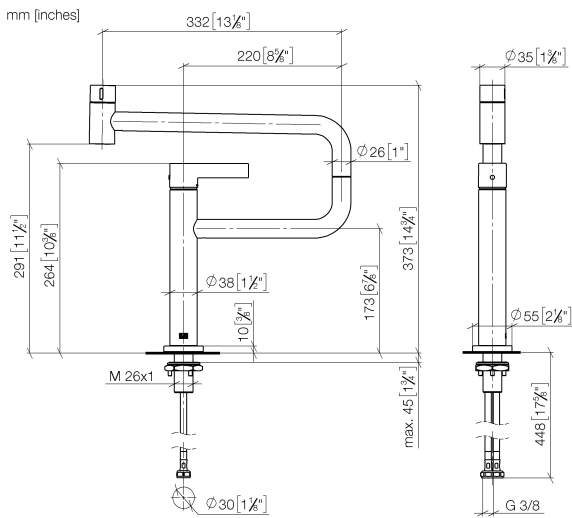

Flow rate chart

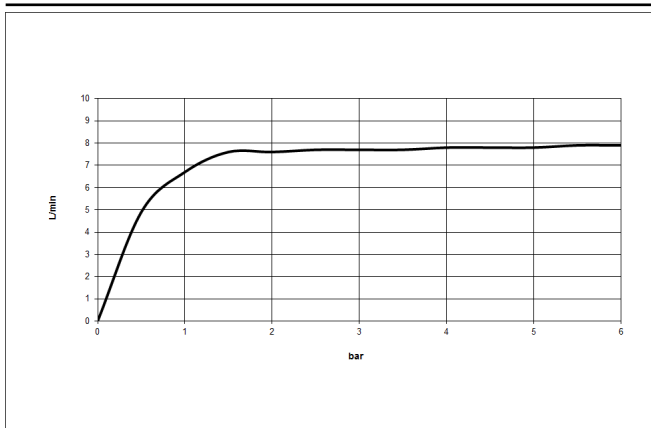

Certificates

LGA\_28059.

GDV\_0400292.

33 845 875

Parts for other finishes can be found here: [Chrome](#)

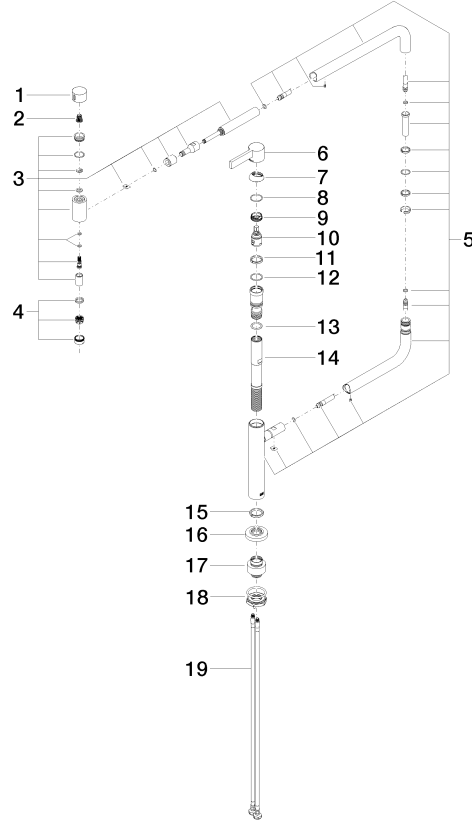

### Spare parts list

No.	Item Number	Name	Quantity used	Delivery time
1	09 20 62 025-46	handle	1	30
2	90 12 12 002 00 90	fixing cap	1	2
3	90 19 87 001 00-46	spout	1	30
4	90 23 01 026 07-46	aerator	1	30
5	90 28 22 257 00-46	joint	1	30
6	90 20 87 004 00-46	handle	1	30
7	09 28 30 013-46	cover	1	30
8	09 14 10 091 90	seal	1	2
9	09 24 04 266 90	nut	1	2
10	90 15 05 042 00 90	cartridge	1	2
11	09 28 10 156 90	ring	1	2
12	90 14 10 063 00 90	seal	1	2
13	09 14 10 081 90	seal	1	2
14	09 30 01 126 90	connection	1	2
15	09 28 10 159 90	ring	1	2
16	09 27 87 033-46	rosette	1	30
17	12 845 970 90	Extension set -	1	2
18	04 30 11 085 87 90	fixing set	1	2
19	04 30 04 101 00 90	hose	2	2