







TARA Profi single-lever mixer - Brushed Dark Platinum

33 880 888



- 200mm projection
- pivotable spout 360°
- air-enriched flow and spray flow
- height of mixer 415 mm
- test
- height up to aerator 275 mm
- hole diameter 35 mm
- sprayface with anti-scaling system
- max. flow 7 l/min at 3 bar flow pressure
- lead-free
- This product can help a building meet the requirements of Green Building Rating Systems, e.g. LEED®, BREEAM®, DGNB

Intrinsic protection against back flow.

| | | |
|---|-----------------------|---------------|
|  | Brushed Dark Platinum | 33 880 888-99 |
|  | Chrome | 33 880 888-00 |
|  | Brushed Platinum | 33 880 888-06 |
|  | Platinum | 33 880 888-08 |
|  | Dark Chrome | 33 880 888-19 |
|  | Brushed Chrome | 33 880 888-93 |

Recommended miscellaneous

Strainer waste with control handle - Brushed Dark Platinum 10 710 970-99



Recommended miscellaneous

Dispenser with rosette - Brushed Dark Platinum 82 444 970-99



TARA Profi single-lever mixer - Brushed Dark Platinum

33 880 888

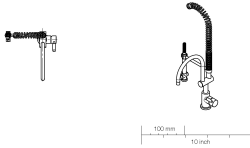
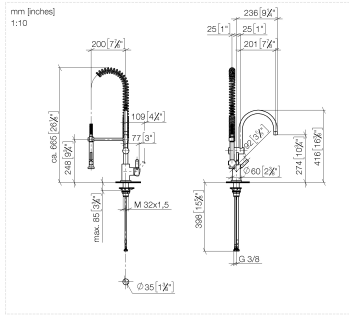

Flow rate chart

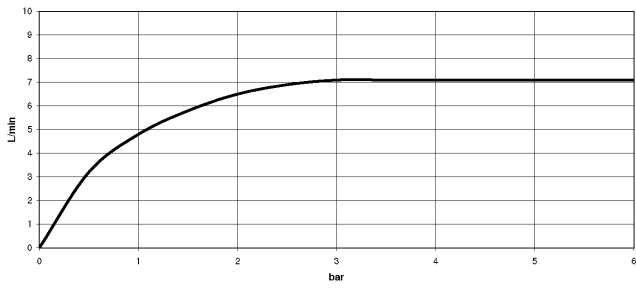

TARA Profi single-lever mixer - Brushed Dark Platinum

33 880 888

Parts for other finishes can be found here: [Chrome](#)

