

Concealed single-lever mixer with cover plate - Brushed Chrome











IMO

36 060 670



- cover plate 80 x 80 mm
- WRAS 2107016

Fits: IMO, MEM, CL.1, CYO

| | | |
|---|-------------------------------------|---------------|
|  | Brushed Chrome | 36 060 670-93 |
|  | Chrome | 36 060 670-00 |
|  | Brushed Platinum | 36 060 670-06 |
|  | Platinum | 36 060 670-08 |
|  | Dark Chrome | 36 060 670-19 |
|  | Brushed Light Gold | 36 060 670-27 |
|  | Brushed Durabronze (23kt Gold) | 36 060 670-28 |
|  | Matte Black | 36 060 670-33 |
|  | Brushed Champagne (22kt Gold) | 36 060 670-46 |
|  | Champagne (22kt Gold) | 36 060 670-47 |
|  | Brushed Dark Platinum | 36 060 670-99 |

Required miscellaneous



Concealed wall-mounted single-lever mixer - 35 860 970 90

- max. recess depth 95 mm
- min. recess depth 75 mm

36 060 670

mm [inches]



Certificates

WRAS_2107016. LGA_29905.

36 060 670

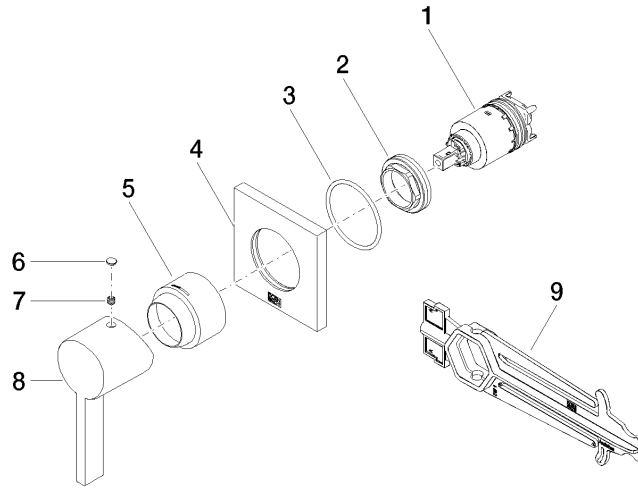

Spare parts list

| No. | Item Number | Name | Quantity used | Delivery time |
|-----|--------------------|-----------|---------------|---------------|
| 1 | 90 15 05 064 01 90 | cartridge | 1 | 2 |
| 2 | 09 24 04 105 90 | nut | 1 | 2 |
| 3 | 90 14 10 049 00 90 | seal | 1 | 2 |
| 4 | 09 27 78 048-93 | rosette | 1 | 20 |
| 5 | 09 11 02 530-93 | cover | 1 | 20 |
| 6 | 90 31 20 087 00-93 | plug | 1 | 20 |
| 7 | 90 31 11 112 00 90 | pin | 1 | 2 |
| 8 | 09 20 67 004-93 | handle | 1 | 20 |
| 9 | 90 30 09 064 00 90 | key | 1 | 2 |