

Concealed single-lever mixer with integrated shower connection with shower set without hand shower - Matte Black

IMO

36 111 970











- metal shower hose 1750mm with integrated anti-twist protection
- slide bar
- Pipe diameter 18 mm
- WRAS 2011027

This article does not include a hand shower!
Intrinsic protection against back flow.

This article does not include a hand shower!

Intrinsic protection against back flow.

Fits: IMO, LULU, MADISON, MEM, TARA, CL.1, LISSÉ, VAIA, META, CYO

	Matte Black	36 111 970-33
	Chrome	36 111 970-00
	Brushed Platinum	36 111 970-06
	Platinum	36 111 970-08
	Dark Chrome	36 111 970-19
	Brushed Light Gold	36 111 970-27
	Brushed Durabronze (23kt Gold)	36 111 970-28
	Brushed Bronze	36 111 970-42
	Brushed Champagne (22kt Gold)	36 111 970-46
	Champagne (22kt Gold)	36 111 970-47
	Brushed Chrome	36 111 970-93
	Brushed Dark Platinum	36 111 970-99

Concealed single-lever mixer with integrated shower connection with shower set without hand shower - Matte Black

IMO

36 111 970

Required miscellaneous



Concealed wall mounting -
 ● max. recess depth 105 mm
 ● min. recess depth 80 mm

35 050 970 90

Required miscellaneous



Hand shower FlowReduce - Matte Black

28 012 979-33
0010

Required miscellaneous



Hand shower - Matte Black

28 017 979-33

Required miscellaneous



Hand shower - Matte Black

28 016 979-33

Required miscellaneous



Hand shower - Matte Black

28 012 979-33

Required miscellaneous



Hand shower FlowReduce - Matte Black

28 016 979-33
0010

Required miscellaneous



Hand shower - Matte Black

28 018 979-33

Required miscellaneous



Hand shower FlowReduce - Matte Black

28 018 979-33
0010

Required miscellaneous



SERIES-VARIOUS Hand shower - Matte Black

28 029 979-33
0010

Required miscellaneous



SERIES-VARIOUS Hand shower - Matte Black

28 029 979-33

Required miscellaneous



SERIES-VARIOUS Hand shower - Matte Black

28 027 979-33
0010

Required miscellaneous



SERIES-VARIOUS Hand shower - Matte Black

28 025 979-33
0010

Concealed single-lever mixer with integrated shower connection with shower set without hand shower - Matte Black

IMO

36 111 970

mm [Inches]

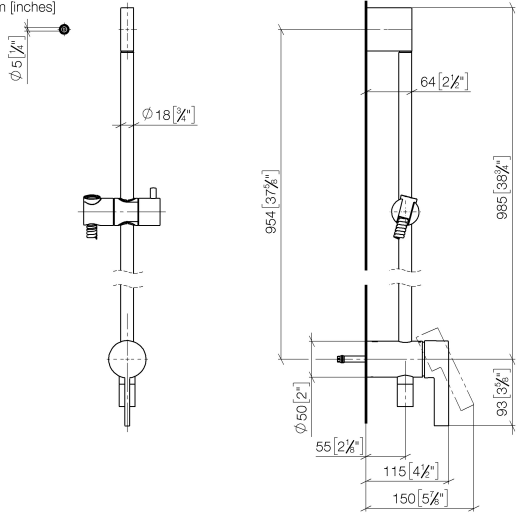

Certificates

Belgaqua_21-025- WRAS_2011027. LGA_29928.
27_1.

36 111 970

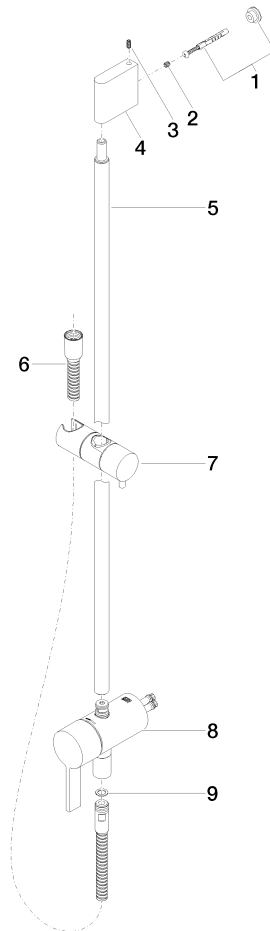

Spare parts list

No.	Item Number	Name	Quantity used	Delivery time
1	05 17 20 726 02 90	fixing set	1	2
2	09 31 11 049 90	pin	2	2
3	04 31 11 113 00 90	pin	2	2
4	08 17 97 054-33	holder	1	30
5	90 28 22 782 00-33	pipe	1	30
6	28 322 970-33	Metal shower hose 1/2" x 3/8" x 1750 mm - Matte Black	1	2
7	12 580 970-33	Slide unit - Matte Black	1	10
8	90 19 97 002 00-33	connection	1	30
9	90 14 20 026 00 90	seal	1	2