

WATER FAN horizontal Concealed body spray - Brushed Chrome













IMO

36 512 979 Product version from 4/1/2024



- forceful flat water jet
- horizontal water jet
- cover plate 240 x 60 mm
- water jet adjustable
- 1/2" connection
- max. flow 10 l/min
- WRAS
- This product can help a building meet the requirements of Green Building Rating Systems, e.g. LEED®, BREEAM®, DGNB

Fits: IMO, LULU, MADISON, MEM, TARA, CL.1, LISSÉ, VAIA, META, CYO

| | | |
|---|--------------------------------|---------------|
|  | Brushed Chrome | 36 512 979-93 |
|  | Chrome | 36 512 979-00 |
|  | Brushed Platinum | 36 512 979-06 |
|  | Platinum | 36 512 979-08 |
|  | Dark Chrome | 36 512 979-19 |
|  | Light Gold | 36 512 979-26 |
|  | Brushed Light Gold | 36 512 979-27 |
|  | Brushed Durabronze (23kt Gold) | 36 512 979-28 |
|  | Matte Black | 36 512 979-33 |
|  | Brushed Bronze | 36 512 979-42 |
|  | Brushed Champagne (22kt Gold) | 36 512 979-46 |
|  | Champagne (22kt Gold) | 36 512 979-47 |
|  | Brushed Dark Platinum | 36 512 979-99 |

Required miscellaneous



Concealed wall installation box - 35 206 970 90
 • max. recess depth mm
 • min. recess depth mm

Recommended miscellaneous



xGRID Attachment set for integrating in the dry wall construction - 12 340 970 90

Required miscellaneous



xGRID Installation track 555 mm - 12 360 970 90

36 512 979 Product version from 4/1/2024

mm [inches]



Flow rate chart

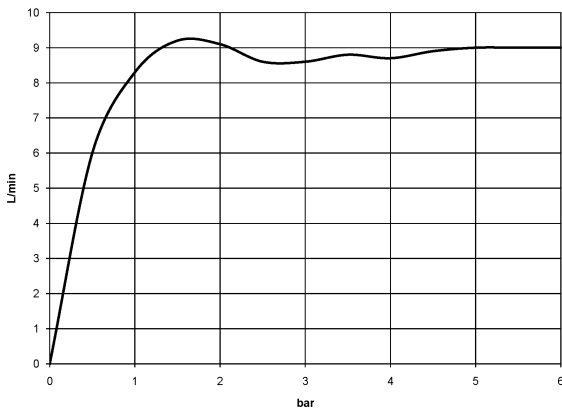

Trajectory diagram

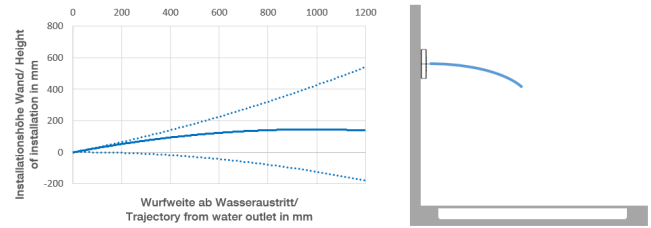

Codes & Standards

DIN 4109

ISO 3822

Scottish Water
Byelaws

UK Water Supply
Regulations

Ü-Zeichen



WATER FAN horizontal Concealed body spray - Brushed Chrome

IMO

36 512 979 Product version from 4/1/2024

Certificates

LGA_29

WRAS_2005

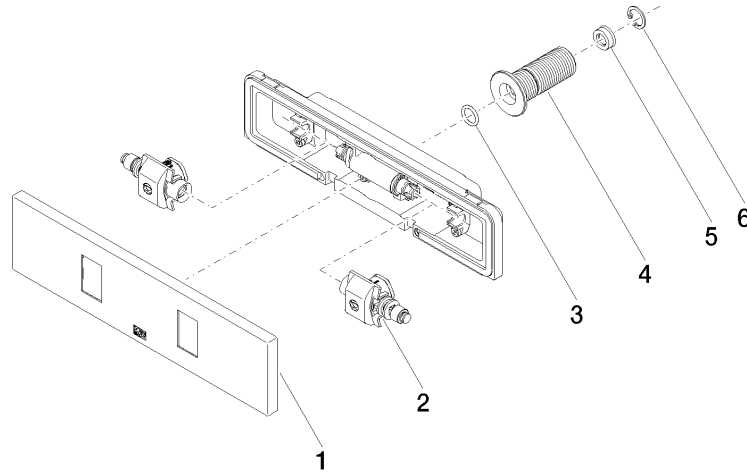

Spare parts list

| No. | Item Number | Name | Quantity used | Delivery time |
|-----|--------------------|--------------|---------------|---------------|
| 1 | 90 27 99 002 00-93 | insert | 1 | 20 |
| 2 | 90 31 10 012 00 90 | insert | 1 | 2 |
| 3 | 09 14 10 003 90 | seal | 1 | 2 |
| 4 | 09 24 05 015 90 | nipple | 1 | 2 |
| 5 | 09 23 01 134 90 | flow reducer | 1 | 2 |
| 6 | 09 16 01 014 90 | ring | 1 | 2 |