











WATER CURVE Concealed body spray - Brushed Champagne (22kt Gold)

36 514 979 Product version from 4/1/2024



- AQUAPRESSURE FLOW, max. flow rate 10 l/min (at 3 bar)
- water jet adjustable
- cover plate 120 x 60 mm
- 1/2" connection
- WRAS

	Brushed Champagne (22kt Gold)	36 514 979-46
	Chrome	36 514 979-00
	Brushed Platinum	36 514 979-06
	Platinum	36 514 979-08
	Dark Chrome	36 514 979-19
	Light Gold	36 514 979-26
	Brushed Light Gold	36 514 979-27
	Brushed Durabrass (23kt Gold)	36 514 979-28
	Matte Black	36 514 979-33
	Brushed Bronze	36 514 979-42
	Champagne (22kt Gold)	36 514 979-47
	Brushed Chrome	36 514 979-93
	Brushed Dark Platinum	36 514 979-99

Recommended miscellaneous



- Concealed wall elbow -** 35 085 970 90
- max. recess depth mm
 - min. recess depth mm

WATER CURVE Concealed body spray - Brushed Champagne (22kt Gold)

36 514 979 Product version from 4/1/2024

mm [inches]

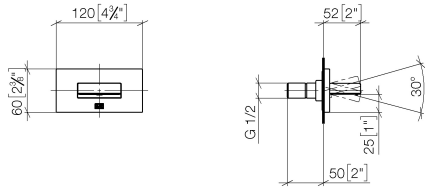

Flow rate chart

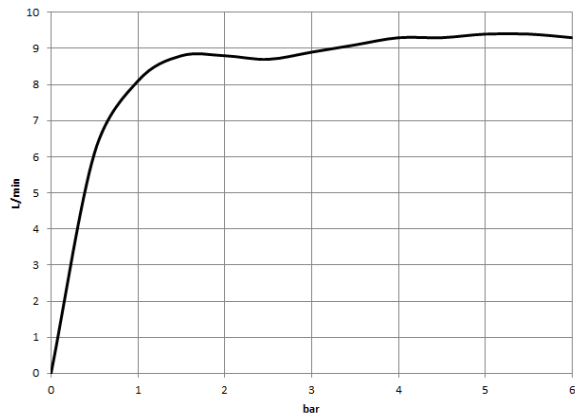

Trajectory diagram

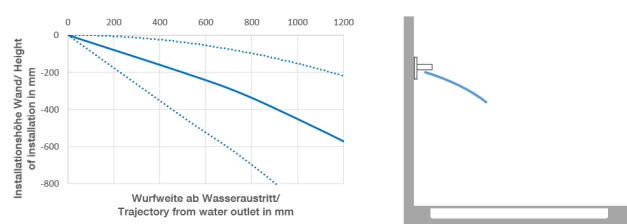

Codes & Standards

DIN 4109

ISO 3822

Ü-Zeichen



WATER CURVE Concealed body spray - Brushed Champagne (22kt Gold)

36 514 979 Product version from 4/1/2024

Certificates

LGA_29

WATER CURVE Concealed body spray - Brushed Champagne (22kt Gold)

36 514 979 Product version from 4/1/2024

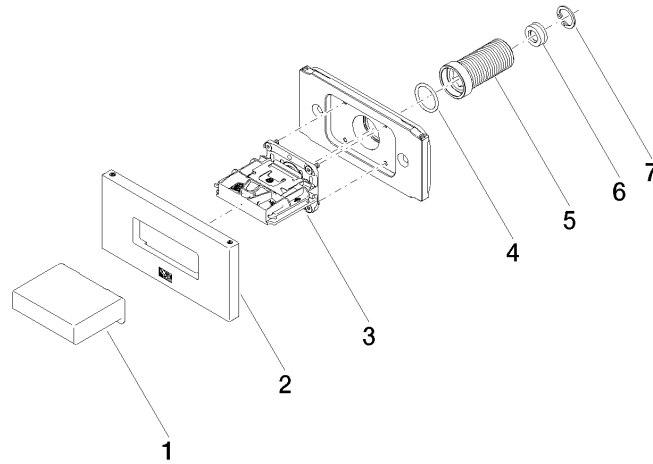

Spare parts list

No.	Item Number	Name	Quantity used	Delivery time
1	09 17 01 230-46	casing	1	30
2	90 27 97 041 00-46	rosette	1	30
3	90 29 03 088 00 90	insert	1	2
4	90 14 10 010 00 90	seal	1	2
5	09 24 04 336 90	nipple	1	2
6	09 23 01 134 90	flow reducer	1	2
7	09 16 01 014 90	ring	1	2