







CL.1 Wall valve anti-clockwise closing hot 1/2" - Brushed Platinum

CL.1

36 607 707



- rosette 60 x 60 mm
- with hot marking
- head part with cut-to-length spindle and sleeve
- WRAS 2010066

	Brushed Platinum	36 607 707-06
	Chrome	36 607 707-00
	Dark Chrome	36 607 707-19
	Brushed Champagne (22kt Gold)	36 607 707-46
	Champagne (22kt Gold)	36 607 707-47
	Brushed Dark Platinum	36 607 707-99

Required miscellaneous



Wall valve 1/2" -

35 607 970 90

- max. recess depth 150 mm
- min. recess depth 105 mm



CL.1 Wall valve anti-clockwise closing hot 1/2" - Brushed Platinum

CL.1

36 607 707

mm [inches]

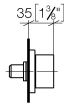

Codes & Standards

DIN 4109	EN 200	ISO 3822	Scottish Water Byelaws
UK Water Supply Regulations	Ü-Zeichen		

Certificates

DVGW_DW- 6501DN0	WRAS_2010	LGA_29	LGA_29
---------------------	-----------	--------	--------

36 607 707

Product version up to 10/14/2020

Product version from 10/14/2020

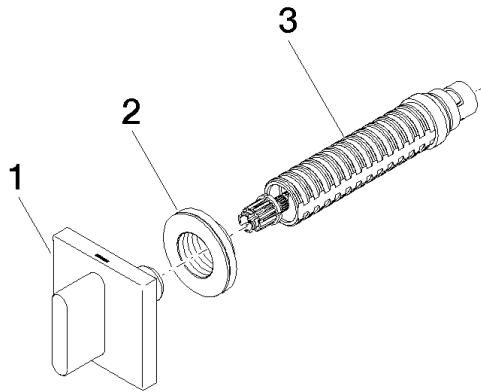



CL.1 Wall valve anti-clockwise closing hot 1/2" - Brushed Platinum

CL.1

36 607 707

Spare parts list

Product version up to 10/14/2020

Product version from 10/14/2020

No.	Item Number	Name	Quantity used	Delivery time
	90 20 70 051 03-06	handle (hot)	3	10