









36 607 819



- rosette Ø 60 mm
- head part with cut-to-length spindle and sleeve
- WRAS 2011026, 2010066

	Champagne (22kt Gold)	36 607 819-47
	Chrome	36 607 819-00
	Brushed Platinum	36 607 819-06
	Platinum	36 607 819-08
	Dark Chrome	36 607 819-19
	Brushed Durabronze (23kt Gold)	36 607 819-28
	Brushed Bronze	36 607 819-42
	Brushed Champagne (22kt Gold)	36 607 819-46
	Brushed Dark Platinum	36 607 819-99

Required miscellaneous

- Wall valve 1/2" -** 35 607 970 90
- max. recess depth 145 mm
 - min. recess depth 75 mm



36 607 819

mm [inches]

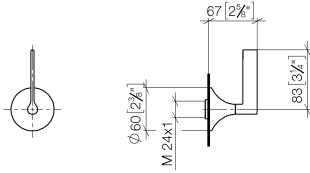

Certificates

DVGW_DW-
6501DN0116.

WRAS_2011026.

LGA_29931.

WRAS_2010066.

DVGW_DW-
6512DN0706.

36 607 819

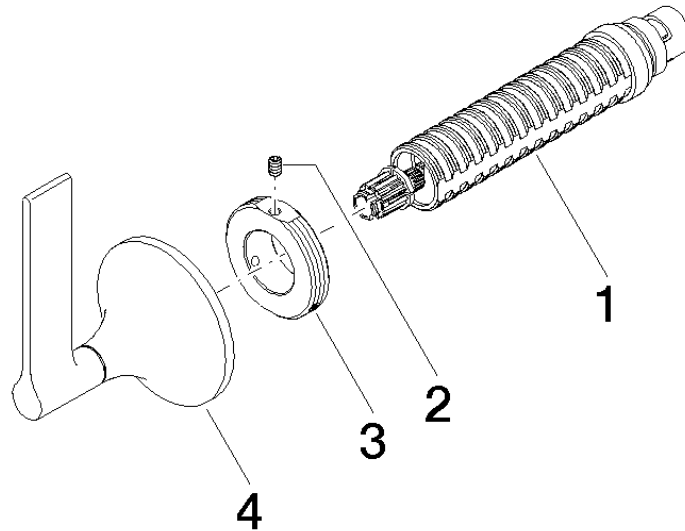

Spare parts list

No.	Item Number	Name	Quantity used	Delivery time
1	90 90 03 143 00 90	top	1	2
2	09 31 11 008 90	pin	1	2
3	09 21 02 163 90	disc	1	2
4	90 20 80 015 00-47	handle	1	30