

ST 050 203 9979



Fits: IMO, LULU, MEM, TARA, CL.1, LISSÉ, VAIA, META, CYO

- slide bar
- Pipe diameter 18 mm
- gauge 853 mm
- metal shower hose 1750mm with integrated anti-twist protection
- shower hose connector 3/8"
- Three or five settings: COMPACT RAIN, COMPACT SOFT FLOW, COMPACT AQUAPRESSURE FLOW, max. flow rate 15 l/min (at 3 bar)
- Function from: 7 l/min
- spray head Ø 100mm

	Platinum	ST 050 203 9979-08
	Chrome	ST 050 203 9979-00
	Chrome	ST 050 203 2979-00 0010
	Brushed Platinum	ST 050 203 9979-06
	Brushed Platinum	ST 050 203 2979-06 0010
	Platinum	ST 050 203 2979-08 0010
	Dark Chrome	ST 050 203 9979-19
	Dark Chrome	ST 050 203 2979-19 0010
	Light Gold	ST 050 203 2979-26 0010
	Light Gold	ST 050 203 9979-26
	Brushed Light Gold	ST 050 203 9979-27
	Brushed Light Gold	ST 050 203 2979-27 0010
	Brushed Durabronze (23kt Gold)	ST 050 203 9979-28
	Brushed Durabronze (23kt Gold)	ST 050 203 2979-28 0010
	Matte Black	ST 050 203 9979-33
	Matte Black	ST 050 203 2979-33 0010
	Brushed Bronze	ST 050 203 2979-42 0010
	Brushed Bronze	ST 050 203 9979-42
	Brushed Champagne (22kt Gold)	ST 050 203 9979-46
	Brushed Champagne (22kt Gold)	ST 050 203 2979-46 0010
	Champagne (22kt Gold)	ST 050 203 9979-47
	Champagne (22kt Gold)	ST 050 203 2979-47 0010
	Brushed Chrome	ST 050 203 9979-93
	Brushed Chrome	ST 050 203 2979-93 0010
	Brushed Dark Platinum	ST 050 203 9979-99
	Brushed Dark Platinum	ST 050 203 2979-99 0010

ST 050 203 9979

Individual components of this set

You need the following components for this set



1x 26 413 979-08



1x 28 018 979-08



Shower set - Platinum

IMO

ST 050 203 9979













ST 050 203 9979



Fits: IMO, LULU, MEM, TARA, CL.1, LISSÉ,
VAIA, META, CYO

- slide bar
- Pipe diameter 18 mm
- gauge 853 mm
- metal shower hose 1750mm with integrated anti-twist protection
- shower hose connector 3/8"
- WRAS 2009048

This article does not include a hand shower!

	Platinum	26 413 979-08
	Chrome	26 413 979-00
	Brushed Platinum	26 413 979-06
	Dark Chrome	26 413 979-19
	Light Gold	26 413 979-26
	Brushed Light Gold	26 413 979-27
	Brushed Durabronze (23kt Gold)	26 413 979-28
	Matte Black	26 413 979-33
	Brushed Bronze	26 413 979-42
	Brushed Champagne (22kt Gold)	26 413 979-46
	Champagne (22kt Gold)	26 413 979-47
	Brushed Chrome	26 413 979-93
	Brushed Dark Platinum	26 413 979-99

ST 050 203 9979

Recommended miscellaneous

	Concealed wall elbow - ●max. recess depth 163 mm ●min. recess depth 90 mm	35 085 970 90
---	--	---------------

Required miscellaneous

	Hand shower - Platinum	28 016 979-08
---	-------------------------------	---------------

Required miscellaneous

	Hand shower FlowReduce - Platinum	28 016 979-08 0010
---	--	-----------------------

Required miscellaneous

	Hand shower - Platinum	28 017 979-08
---	-------------------------------	---------------

Required miscellaneous

	Hand shower FlowReduce - Platinum	28 018 979-08 0010
---	--	-----------------------

Required miscellaneous

	SERIES-VARIOUS Hand shower - Platinum	28 029 979-08 0010
---	--	-----------------------

Recommended miscellaneous

	Wall elbow - Platinum	28 450 980-08
---	------------------------------	---------------

Required miscellaneous

	Hand shower - Platinum	28 012 979-08
---	-------------------------------	---------------

Required miscellaneous

	Hand shower FlowReduce - Platinum	28 012 979-08 0010
---	--	-----------------------

Required miscellaneous

	Hand shower - Platinum	28 018 979-08
---	-------------------------------	---------------

Required miscellaneous

	SERIES-VARIOUS Hand shower - Platinum	28 029 979-08
---	--	---------------

Required miscellaneous

	SERIES-VARIOUS Hand shower - Platinum	28 025 979-08 0010
---	--	-----------------------



Shower set - Platinum

IMO

ST 050 203 9979

ST 050 203 9979

mm [inches]

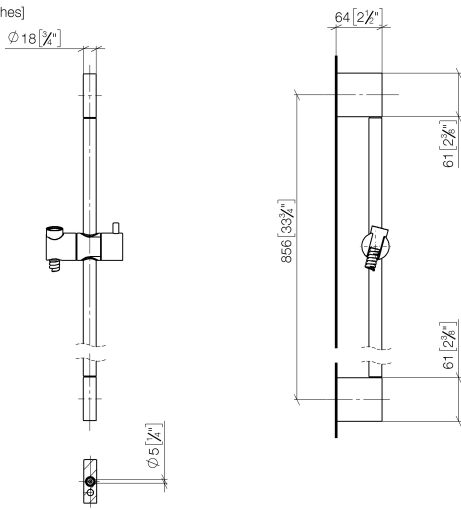

Certificates

WRAS_2009048. ACS_20 ACC LY 738. IAPMO_4976 (1).

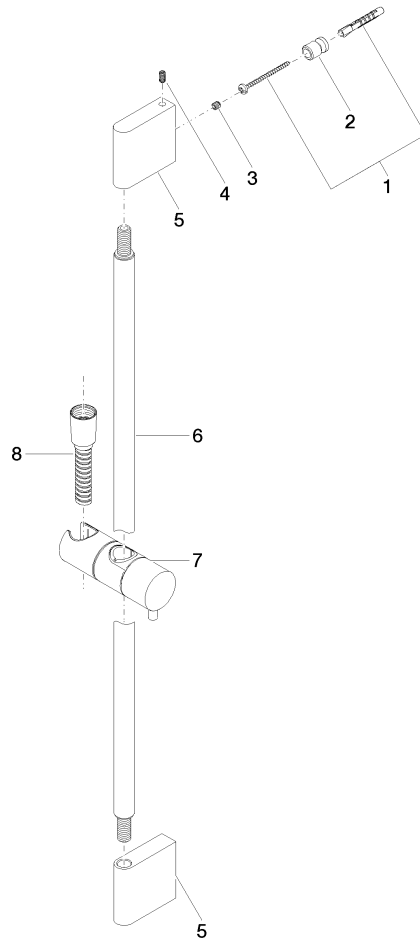

Spare parts list

No.	Item Number	Name	Quantity used	Delivery time
1	05 17 20 726 02 90	fixing set	2	2
2	08 17 20 726 90	holder	2	2
3	09 31 11 049 90	pin	2	2
4	04 31 11 113 00 90	pin	2	2
5	08 17 97 054-08	holder	2	40
6	90 28 22 597 00-08	holder	1	-
Spare part can no longer be ordered, please order the replacement item				
7	12 580 970-08	Slide unit - Platinum	1	40
8	28 322 970-08	Metal shower hose 1/2" x 3/8" x 1750 mm - Platinum	1	40





























ST 050 203 9979



- Three or five settings: COMPACT RAIN, COMPACT SOFT FLOW, COMPACT AQUAPRESSURE FLOW, max. flow rate 15 l/min (at 3 bar)
- with anti-scale system
- spray head Ø 100mm
- 1/2" connection
- WRAS 2210003
- Function from: 7 l/min

Intrinsic protection against back flow.

Fits: IMO, LULU, MADISON, MEM, TARA, CL.1, LISSÉ, VAIA, META, CYO

	Platinum	28 018 979-08
	Chrome	28 018 979-00
	Chrome	28 018 979-00 0010
	Brushed Platinum	28 018 979-06
	Brushed Platinum	28 018 979-06 0010
	Platinum	28 018 979-08 0010
	Dark Brass matt	28 018 979-16 0010
	Dark Bronze matt	28 018 979-17 0010
	Dark Chrome	28 018 979-19
	Dark Chrome	28 018 979-19 0010
	Light Gold	28 018 979-26 0010
	Light Gold	28 018 979-26
	Brushed Light Gold	28 018 979-27 0010
	Brushed Light Gold	28 018 979-27
	Brushed Durabronze (23kt Gold)	28 018 979-28
	Brushed Durabronze (23kt Gold)	28 018 979-28 0010
	Matte Black	28 018 979-33
	Matte Black	28 018 979-33 0010
	Brushed Bronze	28 018 979-42 0010
	Brushed Bronze	28 018 979-42
	Brushed Champagne (22kt Gold)	28 018 979-46
	Brushed Champagne (22kt Gold)	28 018 979-46 0010
	Champagne (22kt Gold)	28 018 979-47
	Champagne (22kt Gold)	28 018 979-47 0010
	Brushed Chrome	28 018 979-93
	Brushed Chrome	28 018 979-93 0010
	Brushed Dark Platinum	28 018 979-99
	Brushed Dark Platinum	28 018 979-99 0010



Shower set - Platinum

IMO

ST 050 203 9979



Shower set - Platinum

IMO

ST 050 203 9979



Shower set - Platinum

IMO

ST 050 203 9979

ST 050 203 9979

mm [inches]

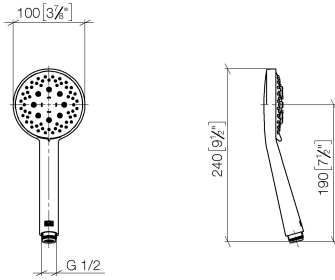

Flow rate chart

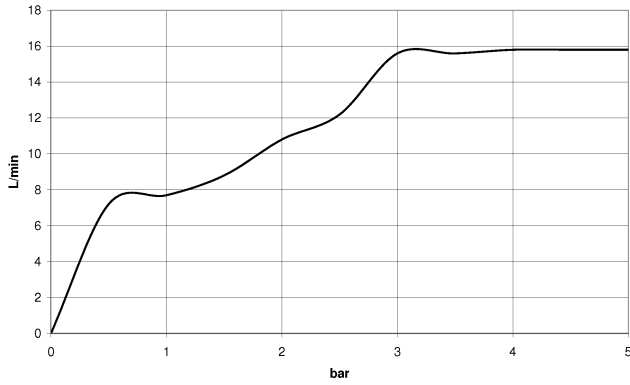

Certificates

LGA_29984.

DVGW_DW-
6517DN0129.

WRAS_2210003.

ST 050 203 9979

Parts for other
finishes can be found
here: [Chrome](#)

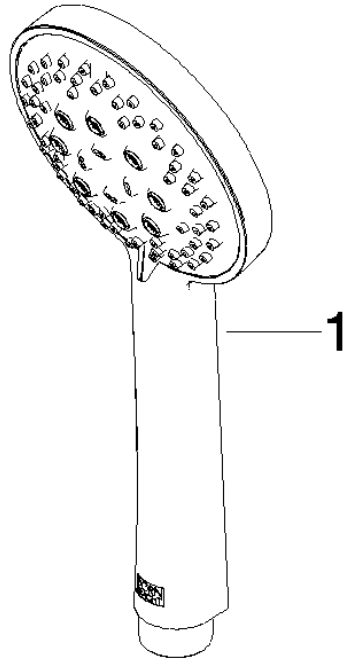

Spare parts list

No.	Item Number	Name	Quantity used	Delivery time
1	09 23 01 039 90	sieve	1	2