

**Concealed single-lever mixer with integrated shower connection with hand shower set - Matte Black**

IMO

ST 050 204 8979



- metal shower hose 1750mm with integrated anti-twist protection
  - Hand shower: COMPACT RAIN, max. flow rate 10 l/min (at 3 bar)
  - spray head Ø 130 mm
- Intrinsic protection against back flow.**

Fits: IMO, LULU, MADISON, MEM, TARA, CL.1, LISSÉ, VAIA, META, CYO

	Matte Black	ST 050 204 8979-33
	Chrome	ST 050 204 8979-00
	Brushed Platinum	ST 050 204 8979-06
	Platinum	ST 050 204 8979-08
	Dark Chrome	ST 050 204 8979-19
	Brushed Durabronze (23kt Gold)	ST 050 204 8979-28
	Brushed Champagne (22kt Gold)	ST 050 204 8979-46
	Champagne (22kt Gold)	ST 050 204 8979-47
	Brushed Chrome	ST 050 204 8979-93
	Brushed Dark Platinum	ST 050 204 8979-99

**Individual components of this set**

You need the following components for this set



1x 36 002 970-33



1x 28 017 979-33



Concealed single-lever mixer with integrated shower connection with hand shower set - Matte Black

---

IMO

ST 050 204 8979

**Concealed single-lever mixer with integrated shower connection with hand shower set - Matte Black**

IMO

ST 050 204 8979



- metal shower hose 1750mm with integrated anti-twist protection
- WRAS 2011027

**This article does not include a hand shower!**  
**Intrinsic protection against back flow.**

This article does not include a hand shower!  
Intrinsic protection against back flow.

Fits: IMO, LULU, MADISON, MEM, TARA, CL.1, LISSÉ, VAIA, META, CYO

	Matte Black	36 002 970-33
	Chrome	36 002 970-00
	Brushed Platinum	36 002 970-06
	Platinum	36 002 970-08
	Dark Chrome	36 002 970-19
	Brushed Light Gold	36 002 970-27
	Brushed Durabronze (23kt Gold)	36 002 970-28
	Brushed Bronze	36 002 970-42
	Brushed Champagne (22kt Gold)	36 002 970-46
	Champagne (22kt Gold)	36 002 970-47
	Brushed Chrome	36 002 970-93
	Brushed Dark Platinum	36 002 970-99

**Required miscellaneous**



**Concealed wall mounting -** 35 050 970 90  
 •max. recess depth 105 mm  
 •min. recess depth 80 mm

**Required miscellaneous**



**Hand shower - Matte Black** 28 017 979-33

**Required miscellaneous**



**Hand shower - Matte Black** 28 012 979-33

**Required miscellaneous**



**Hand shower - Matte Black** 28 018 979-33

**Required miscellaneous**



**SERIES-VARIOUS Hand shower - Matte Black** 28 029 979-33 0010

**Required miscellaneous**



**SERIES-VARIOUS Hand shower - Matte Black** 28 027 979-33 0010

**Required miscellaneous**



**Hand shower FlowReduce - Matte Black** 28 012 979-33 0010

**Required miscellaneous**



**Hand shower - Matte Black** 28 016 979-33

**Required miscellaneous**



**Hand shower FlowReduce - Matte Black** 28 016 979-33 0010

**Required miscellaneous**



**Hand shower FlowReduce - Matte Black** 28 018 979-33 0010

**Required miscellaneous**



**SERIES-VARIOUS Hand shower - Matte Black** 28 029 979-33

**Required miscellaneous**



**SERIES-VARIOUS Hand shower - Matte Black** 28 025 979-33 0010

**Concealed single-lever mixer with integrated shower connection with hand shower set - Matte Black**

ST 050 204 8070  
mm [inches]

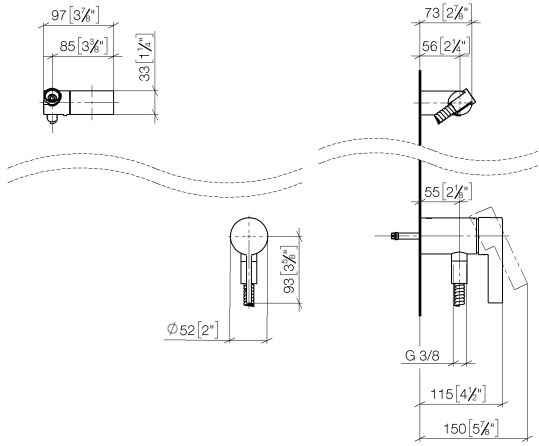

**Certificates**

Belgaqua\_21-025- WRAS\_2011027. LGA\_29928.  
27\_1.

ST 050 204 8979

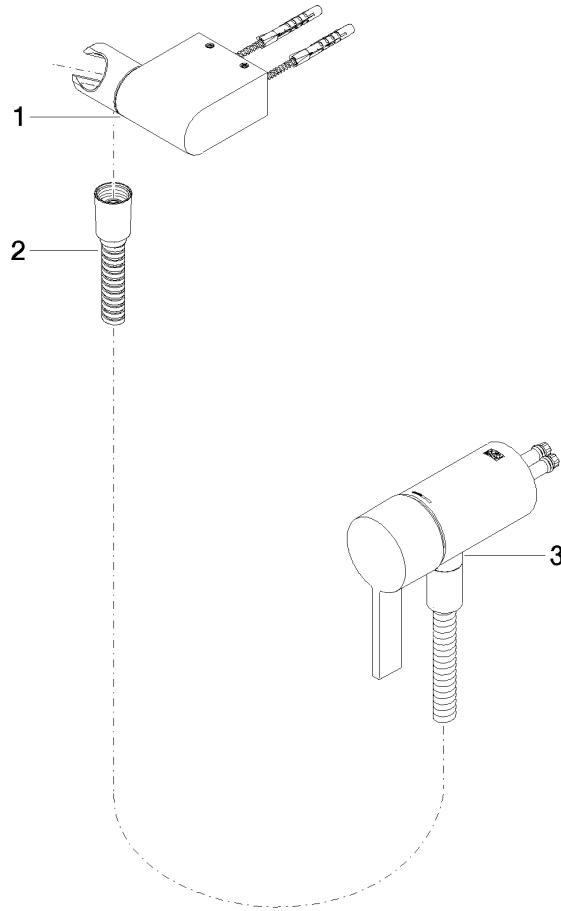

Spare parts list

No.	Item Number	Name	Quantity used	Delivery time
1	28 060 970-33	Wall bracket swivel - Matte Black	1	30
2	28 322 970-33	Metal shower hose 1/2" x 3/8" x 1750 mm - Matte Black	1	2
3	36 050 970-33	Concealed single-lever mixer with integrated shower connection - Matte Black	1	30

**Concealed single-lever mixer with integrated shower connection with hand shower set - Matte Black**

IMO



























ST 050 204 8979



- COMPACT RAIN, max. flow rate 15 l/min (at 3 bar)
- with anti-scale system
- spray head Ø 130 mm
- 1/2" connection
- WRAS 2009011

Intrinsic protection against back flow.

Fits: IMO, LULU, MADISON, MEM, TARA, CL.1, LISSÉ, VAIA, META, CYO

	Matte Black	28 017 979-33
	Chrome	28 017 979-00 0010
	Chrome	28 017 979-00
	Brushed Platinum	28 017 979-06 0010
	Brushed Platinum	28 017 979-06
	Platinum	28 017 979-08 0010
	Platinum	28 017 979-08
	Dark Chrome	28 017 979-19
	Dark Chrome	28 017 979-19 0010
	Light Gold	28 017 979-26 0010
	Light Gold	28 017 979-26
	Brushed Light Gold	28 017 979-27 0010
	Brushed Light Gold	28 017 979-27
	Brushed Durabronze (23kt Gold)	28 017 979-28
	Brushed Durabronze (23kt Gold)	28 017 979-28 0010
	Matte Black	28 017 979-33 0010
	Brushed Bronze	28 017 979-42 0010
	Brushed Bronze	28 017 979-42
	Brushed Champagne (22kt Gold)	28 017 979-46 0010
	Brushed Champagne (22kt Gold)	28 017 979-46
	Champagne (22kt Gold)	28 017 979-47
	Champagne (22kt Gold)	28 017 979-47 0010
	Brushed Chrome	28 017 979-93
	Brushed Chrome	28 017 979-93 0010
	Brushed Dark Platinum	28 017 979-99
	Brushed Dark Platinum	28 017 979-99 0010



Concealed single-lever mixer with integrated shower connection with hand shower set - Matte Black

---

IMO

ST 050 204 8979



Concealed single-lever mixer with integrated shower connection with hand shower set - Matte Black

---

IMO

ST 050 204 8979





Concealed single-lever mixer with integrated shower connection with hand shower set - Matte Black

---

IMO

ST 050 204 8979

**Concealed single-lever mixer with integrated shower connection with hand shower set - Matte Black**

ST 050 204 8070  
mm [inches]

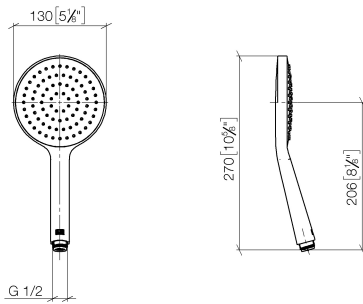

**Flow rate chart**



**Certificates**

DVGW\_DW-  
6517DN0129.

LGA\_29983.

WRAS\_2009011.

Concealed single-lever mixer with integrated shower connection with hand shower set - Matte Black

IMO

ST 050 204 8979  
Parts for other  
finishes can be found  
here: [Chrome](#)



Spare parts list

No.	Item Number	Name	Quantity used	Delivery time
1	09 23 01 039 90	sieve	1	2