







13 805 811



- Ausladung 190 mm
- starrer Auslauf
- rechteckiger luftangereicherter Strahl
- Bohrungsdurchmesser 37 mm
- Anschluss 1/2"
- Durchfluss max. 4,5 l/min
- bleifrei
- Dieses Produkt leistet einen Beitrag zur Erfüllung der Vorgaben von nachhaltigen Gebäudezertifizierungen, z.B. LEED®, BREEAM®, DGNB

	Chrom	13 805 811-00
	Platin gebürstet	13 805 811-06
	Dark Chrome	13 805 811-19
	Messing gebürstet (23kt Gold)	13 805 811-28
	Platin / Platin gebürstet	13 805 811-36
	Messing / Messing gebürstet (23kt Gold)	13 805 811-38
	Dark Platin gebürstet	13 805 811-99

Empfohlenes Zubehör



UP-Wandwinkel -

35 085 970 90

- Max. Einbautiefe 163 mm
- Min. Einbautiefe 90 mm

13 805 811

mm [inches]

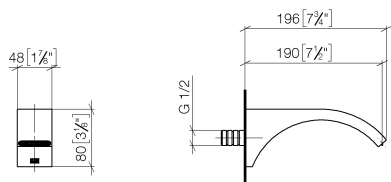

Durchflussdiagramm

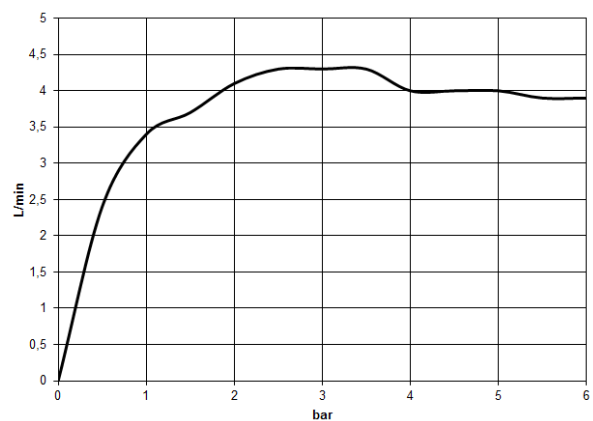

Zertifikate

LGA_38116.

IAPMO_8834 (2).

IAPMO_N-4976.

IAPMO_4976 (6).

IAPMO_6397.

13 805 811

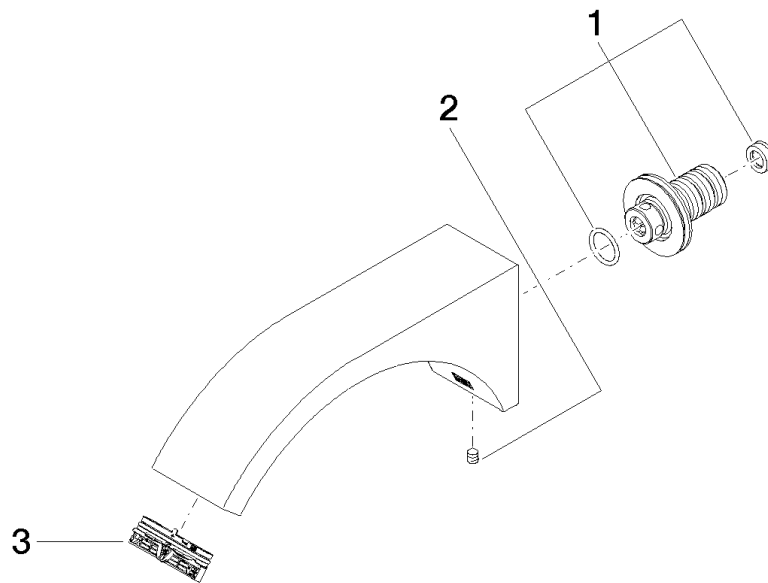

Ersatzteilstückliste

Nr.	Artikelnummer	Benennung	Verbaumenge	Lieferzeit
1	90 24 03 108 01 90	Nippel Set	1	2
2	90 31 11 004 00 90	Stift	1	2
3	90 29 03 121 00 90	Luftsprudler	1	2