







20 000 715

- Bohrungsdurchmesser 32 mm
- Rosette 60 x 60 mm
- mit Warmkennzeichnung



Passt zu: CL.1, CYO

	Dark Chrome	20 000 715-19
	Chrom	20 000 715-00
	Platin gebürstet	20 000 715-06
	Messing gebürstet (23kt Gold)	20 000 715-28
	Champagne gebürstet (22kt Gold)	20 000 715-46
	Champagne (22kt Gold)	20 000 715-47
	Dark Platin gebürstet	20 000 715-99

20 000 715

mm [inches]

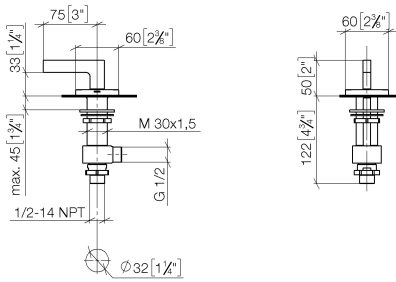

**Durchflussdiagramm**



20 000 715

Ersatzteile für die  
anderen  
Oberflächenvarianten  
finden Sie hier:  
Chrom

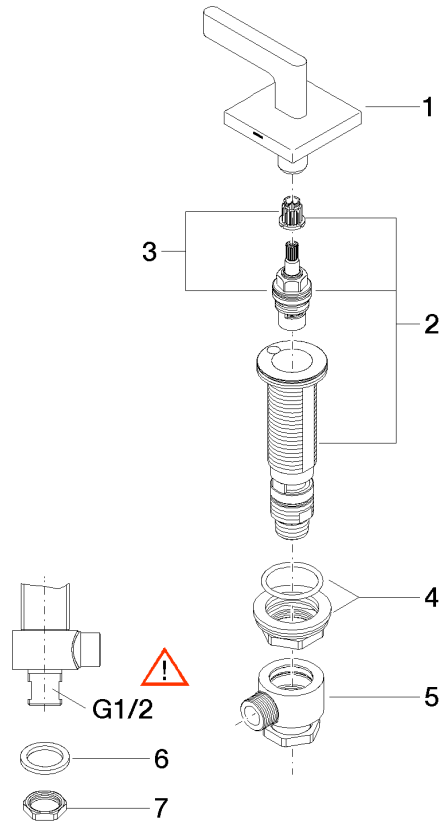

### Ersatzteilstückliste

Nr.	Artikelnummer	Benennung	Verbaumenge	Lieferzeit
1	90 20 70 057 00-19	Griff ( hot )	1	20
2	04 17 11 058 33 90	Seitenteil	1	2
3	90 90 03 133 00 90	Oberteil	1	2
4	04 23 10 032 78 90	Befestigungssatz	1	2
5	04 17 11 023 10 90	Verteiler	1	2
6	09 30 11 059 90	Scheibe	1	2
7	09 23 10 012 90	Mutter	1	2