





28 016 979



- Dreifach bzw. fünffach verstellbar: COMPACT RAIN, COMPACT SOFT FLOW, COMPACT AQUAPRESSURE FLOW, Durchfluss max. 15 l/min (bei 3 Bar)
- mit Antikalk-System
- Brausekopf Ø 130 mm
- Anschluss 1/2"

Eigensicher gegen Rückfließen.

Passt zu: IMO, LULU, MADISON, MEM, TARA, CL.1, LISSÉ, VAIA, META, CYO

	Chrom	28 016 979-00
	Chrom	28 016 979-00 0010
	Platin gebürstet	28 016 979-06
	Platin gebürstet	28 016 979-06 0010
	Platin	28 016 979-08
	Platin	28 016 979-08 0010
	Dark Chrome	28 016 979-19
	Dark Chrome	28 016 979-19 0010
	Light Gold	28 016 979-26
	Light Gold	28 016 979-26 0010
	Light Gold gebürstet	28 016 979-27 0010
	Light Gold gebürstet	28 016 979-27
	Messing gebürstet (23kt Gold)	28 016 979-28
	Messing gebürstet (23kt Gold)	28 016 979-28 0010
	Schwarz matt	28 016 979-33 0010
	Schwarz matt	28 016 979-33
	Bronze gebürstet	28 016 979-42
	Bronze gebürstet	28 016 979-42 0010
	Champagne gebürstet (22kt Gold)	28 016 979-46 0010
	Champagne gebürstet (22kt Gold)	28 016 979-46
	Champagne (22kt Gold)	28 016 979-47
	Champagne (22kt Gold)	28 016 979-47 0010
	Chrom gebürstet	28 016 979-93
	Chrom gebürstet	28 016 979-93 0010
	Dark Platin gebürstet	28 016 979-99 0010
	Dark Platin gebürstet	28 016 979-99



## Handbrause - Chrom

---

IMO

28 016 979

28 016 979

mm [inches]

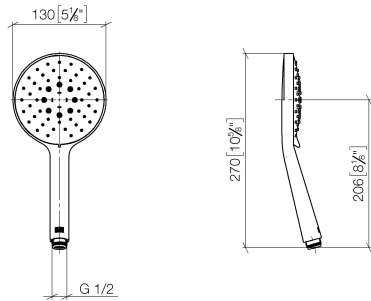

Durchflussdiagramm

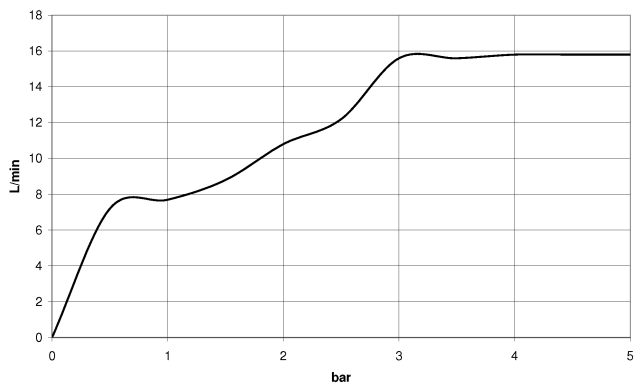

Zertifikate

DVGW\_DW-  
6517DN0129.

LGA\_29982.

WRAS\_2009011.

28 016 979

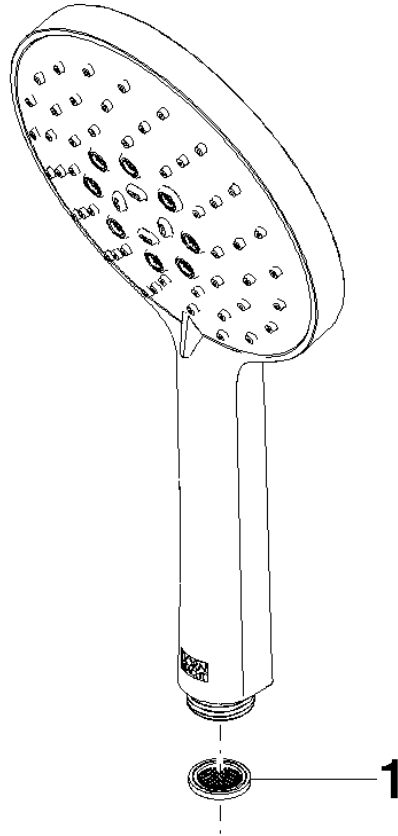

### Ersatzteilstückliste

Nr.	Artikelnummer	Benennung	Verbaumenge	Lieferzeit
1	09 23 01 039 90	Sieb	1	2