













28 450 370



- Brauseabgang 1/2"
- Rosette Ø 60 mm
- Anschluss 1/2"

Eigensicher gegen Rückfließen.

	Messing gebürstet (23kt Gold)	28 450 370-28
	Chrom	28 450 370-00
	Chrom	28 450 370-00 0010
	Platin gebürstet	28 450 370-06
	Platin gebürstet	28 450 370-06 0010
	Platin	28 450 370-08
	Platin	28 450 370-08 0010
	Messing (23kt Gold)	28 450 370-09
	Messing (23kt Gold)	28 450 370-09 0010
	Messing gebürstet (23kt Gold)	28 450 370-28 0010
	Dark Platinum gebürstet	28 450 370-99
	Dark Platinum gebürstet	28 450 370-99 0010

Empfohlenes Zubehör



UP-Wandwinkel -

35 085 970 90

- Max. Einbautiefe 163 mm
- Min. Einbautiefe 90 mm

28 450 370

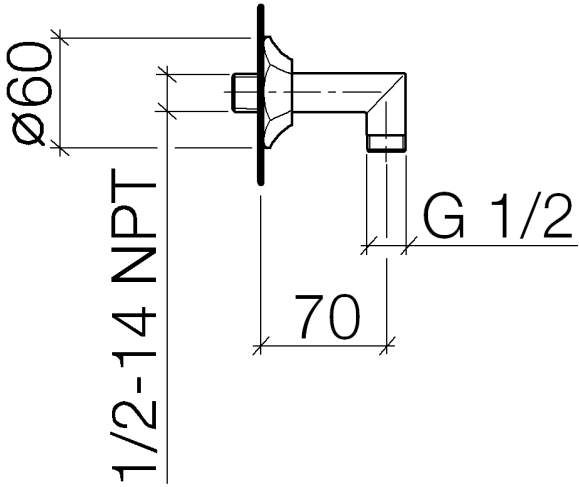

Durchflussdiagramm

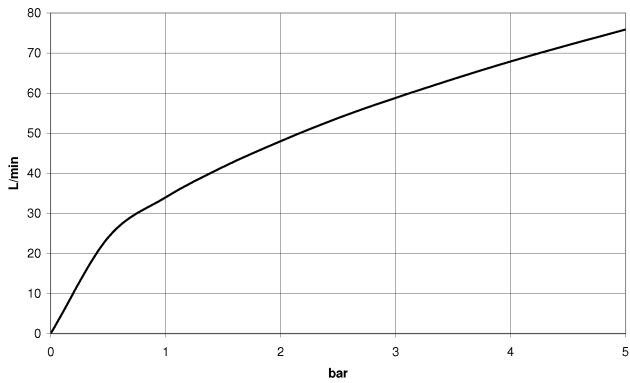

Codes & Standards

EN 1717

Scottish Water
Byelaws

UK Water Supply
Regulations



MADISON Wandanschlussbogen - Messing gebürstet (23kt Gold)

MADISON

28 450 370

Zertifikate

Belgaqua_21-381-2 WRAS_240502

28 450 370

Produktversion bis 7/6/2018

Produktversion ab 7/6/2018

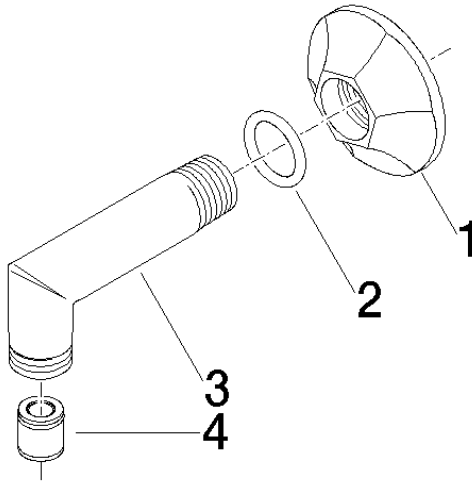



MADISON Wandanschlussbogen - Messing gebürstet (23kt Gold)

MADISON

28 450 370

Ersatzteilstückliste

Produktversion bis 7/6/2018

Produktversion ab 7/6/2018

Nr.	Artikelnummer	Benennung	Verbaumenge	Lieferzeit
	09 27 37 003-28	Rosette	4	20