







28 450 845



- Brauseabgang 3/8"
- Rosette 60 x 78 mm
- Anschluss 1/2"

Eigensicher gegen Rückfließen.

	Dark Platinum gebürstet	28 450 845-99
	Chrom	28 450 845-00
	Platin gebürstet	28 450 845-06
	Dark Chrome	28 450 845-19
	Light Gold gebürstet	28 450 845-27
	Schwarz matt	28 450 845-33
	Chrom gebürstet	28 450 845-93

**Empfohlenes Zubehör**

**UP-Wandwinkel -** 35 085 970 90



- Min. Einbautiefe 90 mm
- Max. Einbautiefe 163 mm

28 450 845

mm [inches]

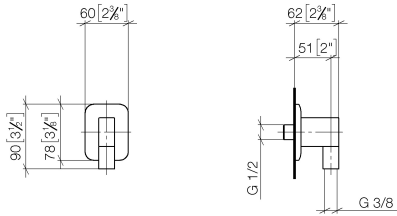

### Durchflussdiagramm



### Zertifikate

WRAS\_2310091.

28 450 845

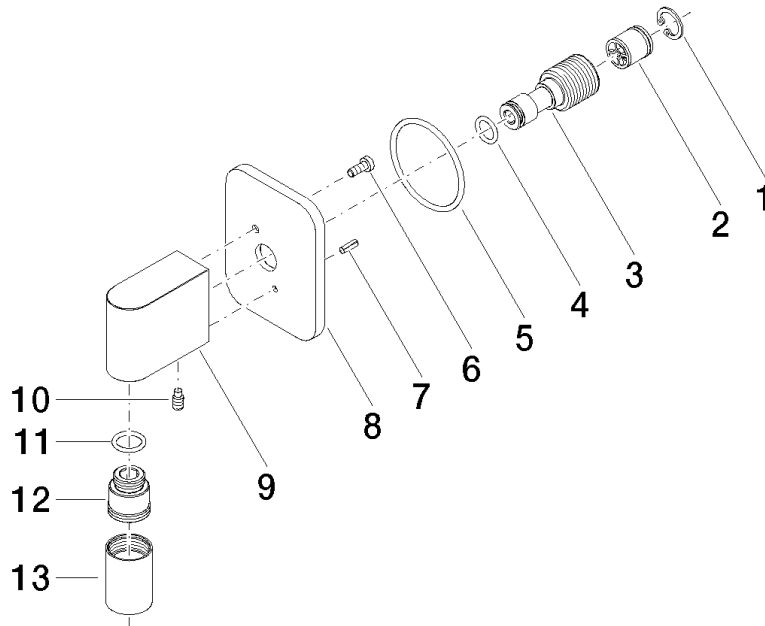

### Ersatzteilstückliste

Nr.	Artikelnummer	Benennung	Verbaumenge	Lieferzeit
1	09 16 01 014 90	Ring	1	2
2	90 23 01 141 00 90	Rueckflussverhinderer	1	2
3	09 24 03 116 20 90	Nippel	1	2
4	09 14 10 008 90	Dichtung	1	2
5	09 14 10 142 90	Dichtung	1	2
6	09 30 30 054 90	Schraube	1	2
7	09 31 11 026 90	Stift	1	2
8	09 27 84 021-99	Rosette	1	60
9	09 11 03 046-99	Anschluss	1	30
10	09 31 11 005 90	Stift	1	2
11	90 14 10 077 00 90	Dichtung	1	2
12	09 24 03 107 20 90	Nippel	1	2
13	90 21 02 069 00-99	Haube	1	30