













28 508 360



- Ausladung 200 mm
- Kugelgelenk 30° schwenkbar
- Dreifach verstellbar: PURIFY RAIN, COMPACT SOFT FLOW, COMPACT AQUAPRESSURE FLOW, Durchfluss max. 7,6 l/min (bei 3 Bar)
- mit Antikalk-System
- Brausekopf Ø 94 mm
- Rosette Ø 55 mm
- Anschluss 1/2"
- Dieses Produkt leistet einen Beitrag zur Erfüllung der Vorgaben von nachhaltigen Gebäudezertifizierungen, z.B. LEED®, BREEAM®, DGNB

| | | |
|---|-------------------------------|--------------------|
|  | Platin | 28 508 360-08 0010 |
|  | Chrom | 28 508 360-00 0010 |
|  | Chrom | 28 508 360-00 |
|  | Platin gebürstet | 28 508 360-06 0010 |
|  | Platin gebürstet | 28 508 360-06 |
|  | Platin | 28 508 360-08 |
|  | Messing (23kt Gold) | 28 508 360-09 0010 |
|  | Messing (23kt Gold) | 28 508 360-09 |
|  | Messing gebürstet (23kt Gold) | 28 508 360-28 0010 |
|  | Messing gebürstet (23kt Gold) | 28 508 360-28 |
|  | Dark Platin gebürstet | 28 508 360-99 0010 |
|  | Dark Platin gebürstet | 28 508 360-99 |

28 508 360

mm [inches]

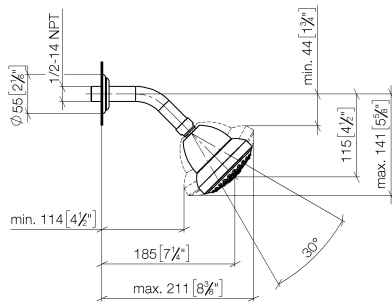

Durchflussdiagramm

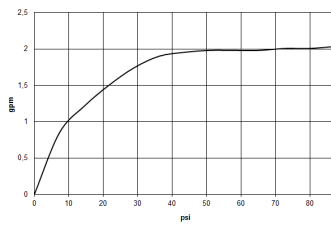

Zertifikate

LGA_38653.

28 508 360

Ersatzteile für die
anderen
Oberflächenvarianten
finden Sie hier:
Chrom

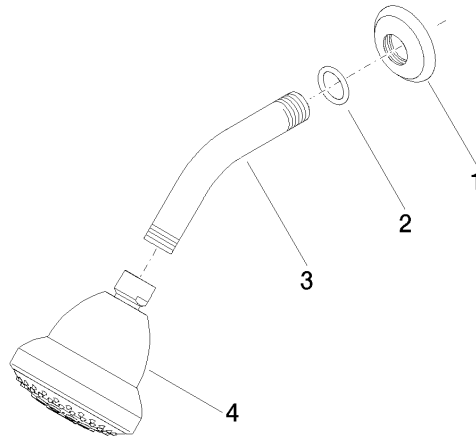

Ersatzteilstückliste

| Nr. | Artikelnummer | Benennung | Verbaumenge | Lieferzeit |
|-----|--------------------|-----------|-------------|------------|
| 1 | 09 27 35 003-08 | Rosette | 1 | 40 |
| 2 | 90 14 10 026 00 90 | Dichtung | 1 | 2 |
| 3 | 09 11 03 011-08 | Anschluss | 1 | 40 |
| 4 | 04 12 11 120 01-08 | Brause | 1 | - |

Ersatzteil nicht mehr bestellbar, bitte bestellen Sie den Nachfolgeartikel