

Kopfbrause - Messing gebürstet (23kt Gold)







IMO

28 508 980



- Ausladung 200 mm
- Kugelgelenk 30° schwenkbar
- Dreifach verstellbar: PURIFY RAIN, COMPACT SOFT FLOW, COMPACT AQUAPRESSURE FLOW, Durchfluss max. 9 l/min (bei 3 Bar)
- Funktion ab: 7 l/min
- mit Antikalk-System
- Brausekopf Ø 92 mm
- Rosette 60 x 60 mm
- Anschluss 1/2"

Passt zu: IMO, MEM, CL.1, CYO

	Messing gebürstet (23kt Gold)	28 508 980-28
	Chrom	28 508 980-00 0010
	Chrom	28 508 980-00
	Platin gebürstet	28 508 980-06 0010
	Platin gebürstet	28 508 980-06
	Platin	28 508 980-08 0010
	Platin	28 508 980-08
	Dark Chrome	28 508 980-19 0010
	Dark Chrome	28 508 980-19
	Light Gold gebürstet	28 508 980-27 0010
	Light Gold gebürstet	28 508 980-27
	Messing gebürstet (23kt Gold)	28 508 980-28 0010
	Schwarz matt	28 508 980-33
	Schwarz matt	28 508 980-33 0010
	Champagne gebürstet (22kt Gold)	28 508 980-46 0010
	Champagne gebürstet (22kt Gold)	28 508 980-46
	Champagne (22kt Gold)	28 508 980-47 0010
	Champagne (22kt Gold)	28 508 980-47
	Chrom gebürstet	28 508 980-93 0010
	Chrom gebürstet	28 508 980-93
	Dark Platin gebürstet	28 508 980-99 0010
	Dark Platin gebürstet	28 508 980-99

28 508 980

Empfohlenes Zubehör



UP-Wandwinkel -

35 085 970 90

- Max. Einbautiefe 163 mm
- Min. Einbautiefe 90 mm

28 508 980

mm [inches]

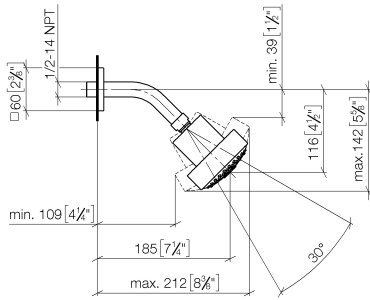

Durchflussdiagramm

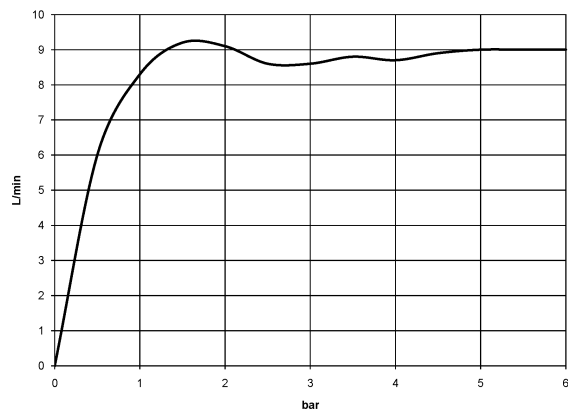

28 508 980

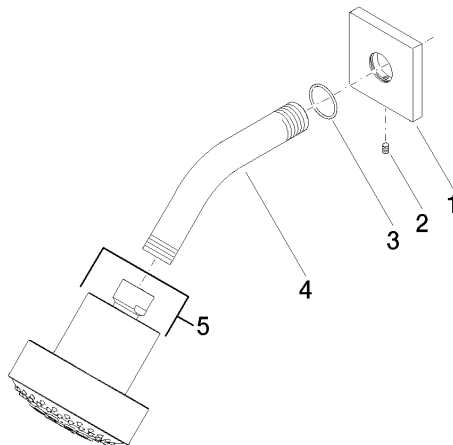

Ersatzteilstückliste

Nr.	Artikelnummer	Benennung	Verbaumenge	Lieferzeit
1	09 27 98 003-28	Rosette	1	20
2	09 31 11 048 90	Stift	1	2
3	09 14 10 098 90	Dichtung	1	2
4	09 11 03 011-28	Anschluss	1	20
5	04 12 11 110 00-28	Brause	1	-

Ersatzteil nicht mehr bestellbar, bitte bestellen Sie den Nachfolgeartikel