







28 545 977



- Ausladung 435 mm
- Regenbrause Ø 200 mm
- PURE RAIN, Durchfluss max. 14 l/min (bei 3 Bar)
- Funktion ab: 8 l/min
- Rosette Ø 55 mm
- Anschluss 1/2"
- mit Antikalk-System

	Platin	28 545 977-08
	Chrom	28 545 977-00
	chrom gebürstet	28 545 977-93
	Platin gebürstet	28 545 977-06
	Messing (23kt Gold)	28 545 977-09
	Messing gebürstet (23kt Gold)	28 545 977-28
	Dark Platin gebürstet	28 545 977-99

Empfohlenes Zubehör



- UP-Wandwinkel -** 35 085 970 90
- Max. Einbautiefe 163 mm
 - Min. Einbautiefe 90 mm

28 545 977



Durchflussdiagramm

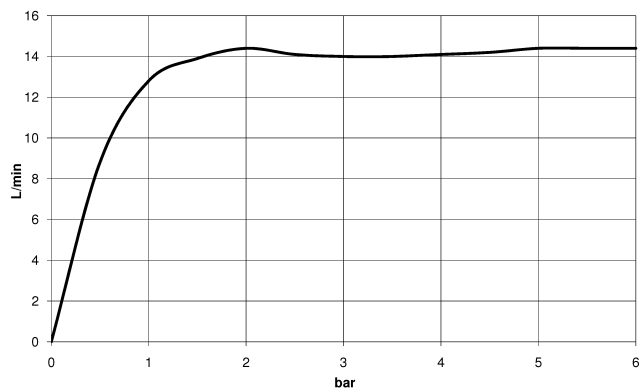

Zertifikate

DVGW_DW- LGA_38654.
6517DN0118.

28 545 977

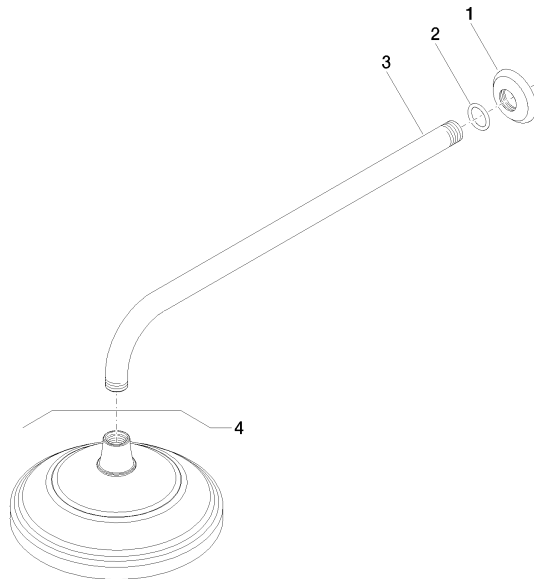

Ersatzteilstückliste

Nr.	Artikelnummer	Benennung	Verbaumenge	Lieferzeit
1	09 27 35 003-08	Rosette	1	40
2	90 14 10 026 00 90	Dichtung	1	2
3	09 11 03 017-08	Anschluss	1	40