





28 659 970



- Ausladung 450 mm
- Regenbrause Ø 400 mm
- PURE RAIN, Durchfluss max. 20 l/min (bei 3 Bar)
- Funktion ab: 12 l/min
- Rosette Ø 60 mm
- Anschluss 1/2"
- mit Antikalk-System

Produktänderung zum 1.4.2024: Durchfluss max. 20l/min

Passt zu: TARA, LISSÉ, VAIA, META

| | | |
|---|---------------------------------|---------------|
|  | Champagne (22kt Gold) | 28 659 970-47 |
|  | Chrom | 28 659 970-00 |
|  | Platin gebürstet | 28 659 970-06 |
|  | Platin | 28 659 970-08 |
|  | Dark Chrome | 28 659 970-19 |
|  | Light Gold | 28 659 970-26 |
|  | Light Gold gebürstet | 28 659 970-27 |
|  | Messing gebürstet (23kt Gold) | 28 659 970-28 |
|  | Schwarz matt | 28 659 970-33 |
|  | Bronze gebürstet | 28 659 970-42 |
|  | Champagne gebürstet (22kt Gold) | 28 659 970-46 |
|  | Chrom gebürstet | 28 659 970-93 |
|  | Dark Platinum gebürstet | 28 659 970-99 |

Empfohlenes Zubehör

UP-Wandwinkel - 35 085 970 90



- Max. Einbautiefe 163 mm
- Min. Einbautiefe 90 mm

28 659 970

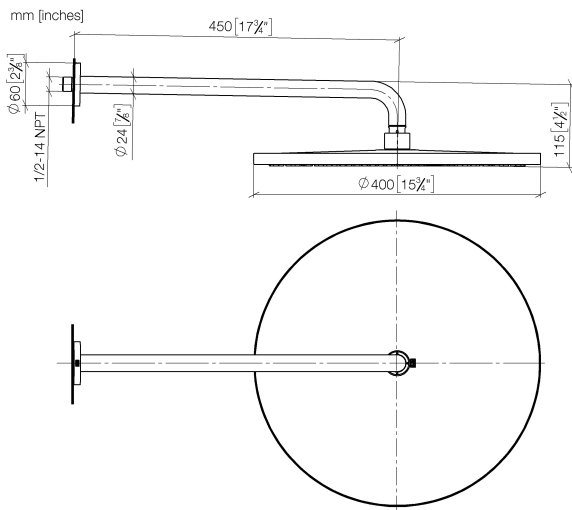

Durchflussdiagramm

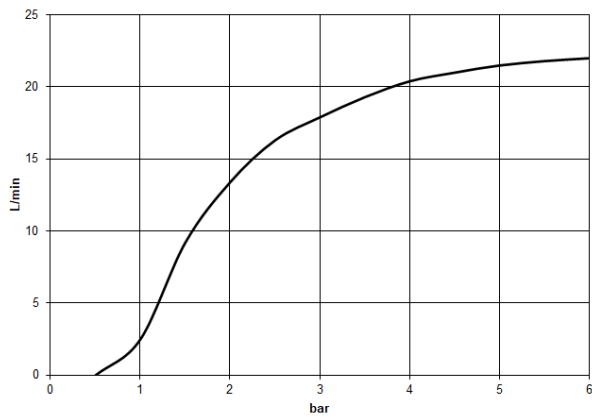

Zertifikate

LGA_29237.

LGA_29238.

WRAS_2212012.

DVGW_DW-6517DN0118.

28 659 970

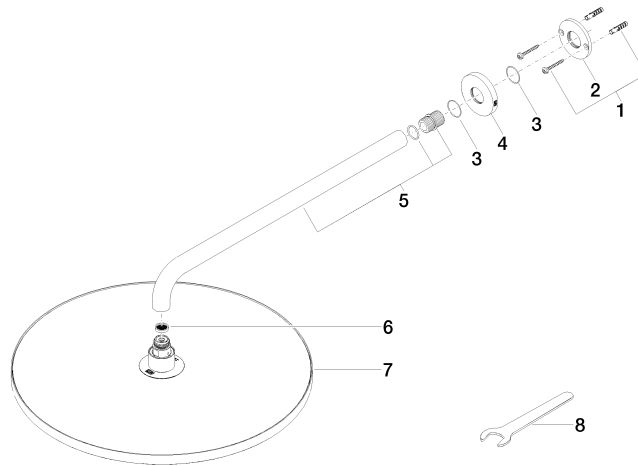

Ersatzteilstückliste

| Nr. | Artikelnummer | Benennung | Verbaumenge | Lieferzeit |
|-----|--------------------|------------------|-------------|------------|
| 1 | 04 30 31 032 00 90 | Befestigungssatz | 1 | 2 |
| 2 | 09 17 20 120 90 | Halter | 1 | 2 |
| 3 | 09 14 10 150 90 | Dichtung | 2 | 2 |
| 4 | 09 27 97 015-47 | Rosette | 1 | 30 |
| 5 | 90 11 03 070 00-47 | Rohr | 1 | 30 |
| 6 | 09 23 01 075 90 | Einsatz | 1 | 2 |
| 7 | 04 12 05 090 00-47 | Brause | 1 | 30 |
| 8 | 90 30 09 069 00 90 | Schlüssel | 1 | 2 |