

33 500 882



- Ausladung 137 mm
- schwenkbarer Auslauf 360°
- runder luftangereicherter Strahl
- Armaturenhöhe 295 mm
- Höhe bis Luftsprudler 187 mm
- Bohrungsdurchmesser 35 mm
- 2x Druckschlauch M 8 x 1 eingeschraubt, dichtheitsgeprüft
- Durchfluss max. 5,7 l/min
- bleifrei
- Dieses Produkt leistet einen Beitrag zur Erfüllung der Vorgaben von nachhaltigen Gebäudezertifizierungen, z.B. LEED®, BREEAM®, DGNB

Nur für Becken mit Überlauf geeignet.

	Chrom	33 500 882-00
	Platin gebürstet	33 500 882-06
	Platin	33 500 882-08
	Dark Chrome	33 500 882-19
	Messing gebürstet (23kt Gold)	33 500 882-28
	Schwarz matt	33 500 882-33
	Champagne gebürstet (22kt Gold)	33 500 882-46
	Champagne (22kt Gold)	33 500 882-47
	Chrom gebürstet	33 500 882-93
	Dark Platin gebürstet	33 500 882-99

33 500 882

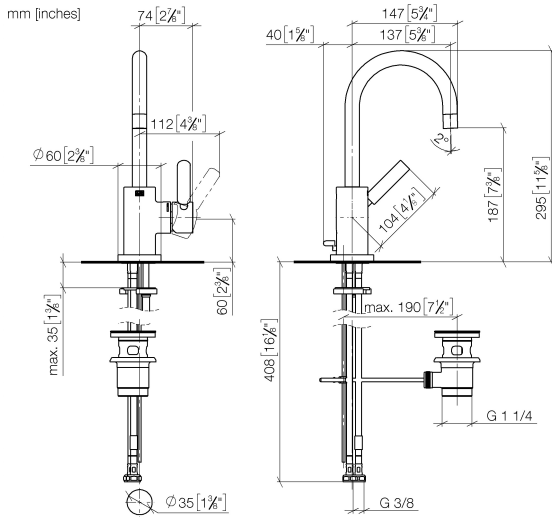

Durchflussdiagramm



Zertifikate

LGA_38418.

WRAS_2212025.

33 500 882

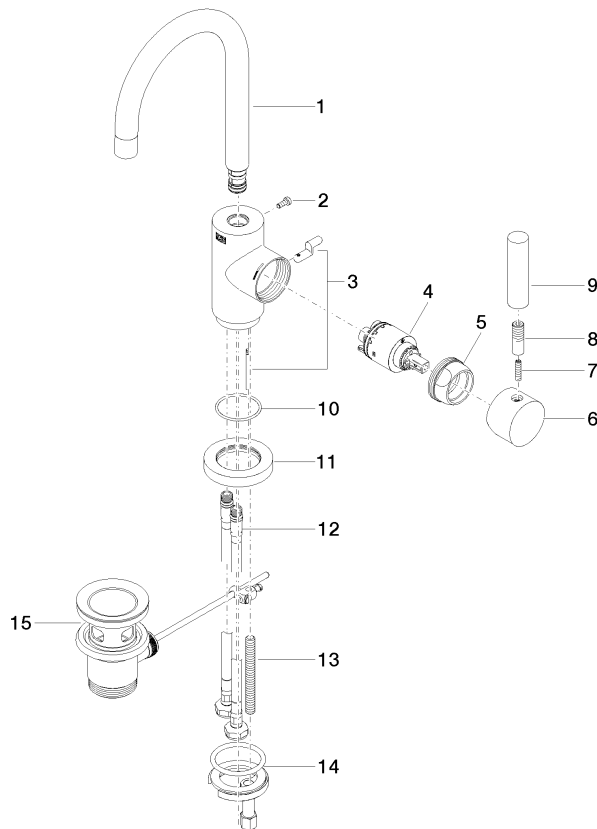

Ersatzteilstückliste

Nr.	Artikelnummer	Benennung	Verbaumenge	Lieferzeit
1	90 28 22 371 00-00	Auslauf	1	10
2	09 30 30 054 90	Schraube	1	2
3	04 20 16 031 80-00	Zugstange	1	10
4	90 15 05 065 00 90	Kartusche	1	2
5	09 24 04 107-00	Mutter	1	10
6	90 20 88 040 00-00	Griff	1	10
7	09 31 11 010 90	Stift	1	2
8	90 24 04 048 00-00	Nippel	1	10
9	11 170 880-00	Griff	1	10
10	09 14 10 034 90	Dichtung	1	2
11	09 28 10 055-00	Rosette	1	10
12	04 30 04 104 00 90	Schlauch	2	2
13	09 31 11 011 90	Stift	1	2
14	04 30 11 038 00 90	Befestigungssatz	1	2
15	90 11 01 001 00-00	Ablaufgarnitur	1	10