











33 800 861



- Ausladung 200 mm
- schwenkbarer Auslauf 360°
- optional schwenkbegrenzbar mit Schwenkbegrenzungsset 12 820 970 90
- luftangereicherter Strahl
- Durchfluss max. 8 l/min bei 3 bar Fließdruck
- bleifrei
- Dieses Produkt leistet einen Beitrag zur Erfüllung der Vorgaben von nachhaltigen Gebäudezertifizierungen, z.B. LEED®, BREEAM®, DGNB

	Messing gebürstet (23kt Gold)	33 800 861-28
	Chrom	33 800 861-00
	Platin gebürstet	33 800 861-06
	Platin	33 800 861-08
	Messing (23kt Gold)	33 800 861-09
	Dark Chrome	33 800 861-19
	Schwarz matt	33 800 861-33
	Champagne gebürstet (22kt Gold)	33 800 861-46
	Champagne (22kt Gold)	33 800 861-47
	Chrom gebürstet (Edelstahl-Look)	33 800 861-93
	Dark Platin gebürstet	33 800 861-99

Empfohlenes Zubehör

Schwenkbegrenzungsset - 12 820 970 90



Empfohlenes Zubehör

Exzenterbetätigung mit Drehknopf - Messing gebürstet (23kt Gold) 10 712 970-28



Empfohlenes Zubehör

Spender ohne Rosette - Messing gebürstet (23kt Gold) 82 424 970-28



33 800 861

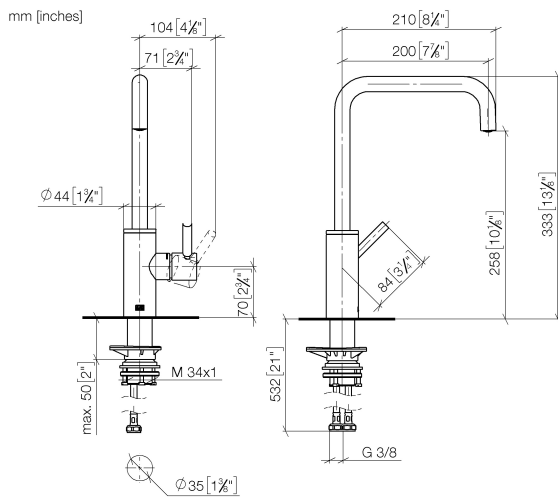

Durchflussdiagramm



Zertifikate

LGA_38642.

WRAS_240102021.

33 800 861

