











33 805 861



- Ausladung 166 mm
- schwenkbarer Auslauf 360°
- optional schwenkbegrenzbar mit Schwenkbegrenzungsset 12 820 970 90
- luftangereicherter Strahl
- Durchfluss max. 8 l/min bei 3 bar Fließdruck
- bleifrei
- Dieses Produkt leistet einen Beitrag zur Erfüllung der Vorgaben von nachhaltigen Gebäudezertifizierungen, z.B. LEED®, BREEAM®, DGNB

|   |                                  |               |
|---|----------------------------------|---------------|
|    | Chrom                            | 33 805 861-00 |
|    | Platin gebürstet                 | 33 805 861-06 |
|    | Platin                           | 33 805 861-08 |
|    | Messing (23kt Gold)              | 33 805 861-09 |
|    | Dark Chrome                      | 33 805 861-19 |
|    | Messing gebürstet (23kt Gold)    | 33 805 861-28 |
|    | Schwarz matt                     | 33 805 861-33 |
|    | Champagne gebürstet (22kt Gold)  | 33 805 861-46 |
|    | Champagne (22kt Gold)            | 33 805 861-47 |
|   | Chrom gebürstet (Edelstahl-Look) | 33 805 861-93 |
|  | Dark Platinum gebürstet          | 33 805 861-99 |

**Empfohlenes Zubehör**

**Schwenkbegrenzungsset - 12 820 970 90**



**Empfohlenes Zubehör**

**Spender ohne Rosette - Chrom 82 424 970-00**



**Empfohlenes Zubehör**

**Exzenterbetätigung mit Drehknopf - Chrom 10 712 970-00**



33 805 861

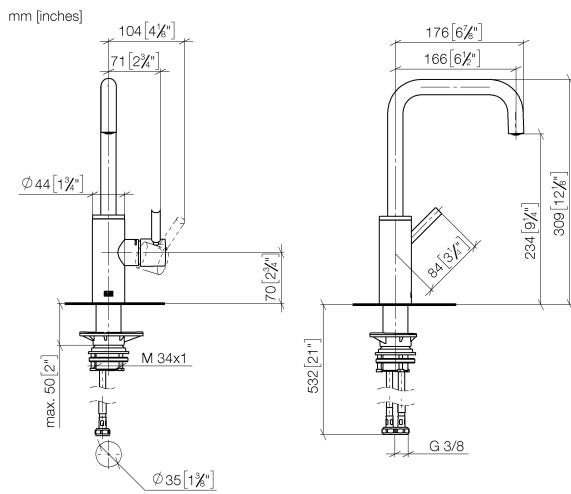

**Durchflussdiagramm**



**Zertifikate**

LGA\_38642.

WRAS\_240102021.

33 805 861

