











33 805 875



- Ausladung 166 mm
- schwenkbarer Auslauf 360°
- Laminarstrahl
- Armaturenhöhe 303 mm
- Höhe bis Laminarstrahlregler 186 mm
- Bohrungsdurchmesser 35 mm
- Durchfluss max. 8 l/min bei 3 bar Fließdruck
- bleifrei
- Dieses Produkt leistet einen Beitrag zur Erfüllung der Vorgaben von nachhaltigen Gebäudezertifizierungen, z.B. LEED®, BREEAM®, DGNB

	Platin gebürstet	33 805 875-06
	Chrom	33 805 875-00
	Platin	33 805 875-08
	Messing (23kt Gold)	33 805 875-09
	Dark Chrome	33 805 875-19
	Messing gebürstet (23kt Gold)	33 805 875-28
	Schwarz matt	33 805 875-33
	Champagne gebürstet (22kt Gold)	33 805 875-46
	Champagne (22kt Gold)	33 805 875-47
	Chrom gebürstet (Edelstahl-Look)	33 805 875-93
	Dark Platin gebürstet	33 805 875-99

Empfohlenes Zubehör

Exzenterbetätigung mit Drehknopf - Platin gebürstet 10 712 970-06



Empfohlenes Zubehör

Spender ohne Rosette - Platin gebürstet 82 424 970-06



33 805 875

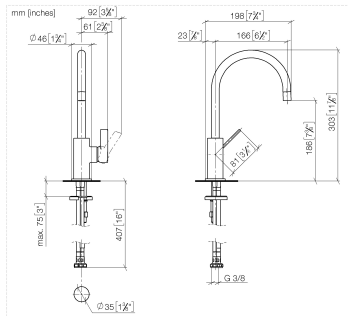

Durchflussdiagramm



Zertifikate

LGA_18899.

33 805 875

Ersatzteile für die
anderen
Oberflächenvarianten
finden Sie hier:
Chrom



Ersatzteilstückliste

Nr.	Artikelnummer	Benennung	Verbaumenge	Lieferzeit
1	90 28 22 206 00-06	Auslauf	1	10
2	90 23 01 067 00-06	Luftsprudler	1	10
3	09 31 11 008 90	Stift	1	2
4	90 15 05 041 00 90	Kartusche	1	2
5	09 24 04 130-07	Mutter	1	30
6	09 24 04 204-06	Haube	1	10
7	90 31 20 109 00 90	Stopfen	1	2
8	90 31 11 030 00 90	Stift	1	2
9	09 20 88 051-06	Griff	1	10
10	09 14 10 118 90	Dichtung	1	2
11	09 27 85 001-06	Rosette	1	10
12	04 30 11 038 64 90	Befestigungssatz	1	2
13	04 30 04 016 00 90	Schlauch	2	60
14	09 31 11 011 90	Stift	1	2
15	12 803 970 90	Verlaengerung	1	60