











33 815 861



- Ausladung 235 mm
- schwenkbarer Auslauf 360°
- optional schwenkbegrenzbar mit Schwenkbegrenzungsset 12 820 970 90
- luftangereicherter Strahl
- Durchfluss max. 8 l/min bei 3 bar Fließdruck
- bleifrei
- Dieses Produkt leistet einen Beitrag zur Erfüllung der Vorgaben von nachhaltigen Gebäudezertifizierungen, z.B. LEED®, BREEAM®, DGNB

	Messing gebürstet (23kt Gold)	33 815 861-28
	Chrom	33 815 861-00
	Platin gebürstet	33 815 861-06
	Platin	33 815 861-08
	Messing (23kt Gold)	33 815 861-09
	Dark Chrome	33 815 861-19
	Schwarz matt	33 815 861-33
	Champagne gebürstet (22kt Gold)	33 815 861-46
	Champagne (22kt Gold)	33 815 861-47
	Chrom gebürstet (Edelstahl-Look)	33 815 861-93
	Dark Platinum gebürstet	33 815 861-99

Empfohlenes Zubehör



Schwenkbegrenzungsset - 12 820 970 90

Empfohlenes Zubehör



Exzenterbetätigung mit Drehknopf - Messing gebürstet (23kt Gold) 10 712 970-28

Empfohlenes Zubehör



Spender ohne Rosette - Messing gebürstet (23kt Gold) 82 424 970-28

33 815 861

mm [inches]

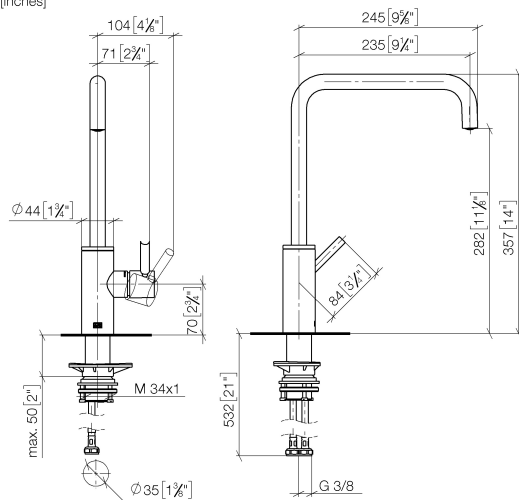

Durchflussdiagramm

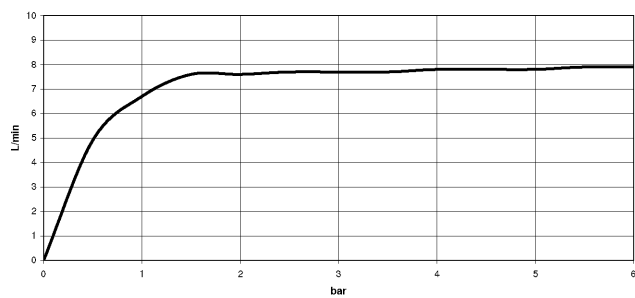

Zertifikate

LGA_38642.

WRAS_240102021.

33 815 861

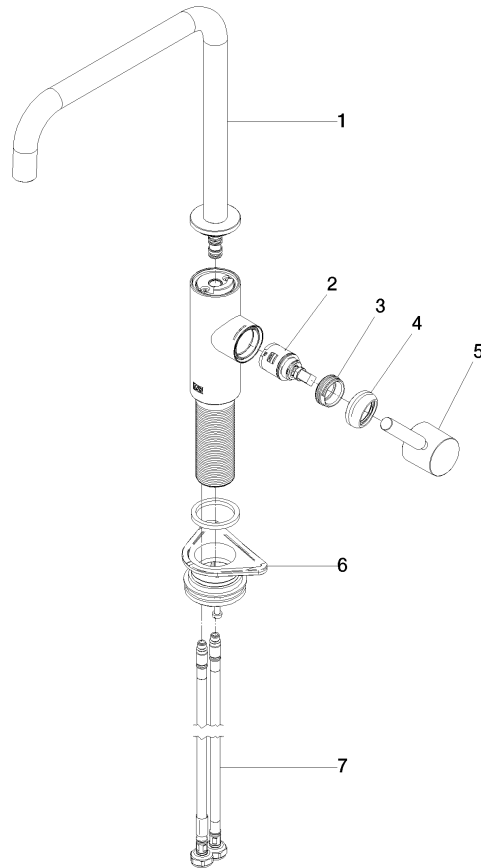

Ersatzteilstückliste

Nr.	Artikelnummer	Benennung	Verbaumenge	Lieferzeit
1	90 28 22 284 00-28	Auslauf	1	20
2	90 15 05 042 00 90	Kartusche	1	2
3	09 24 04 266 90	Mutter	1	2
4	90 28 30 052 00-28	Haube	1	20
5	90 20 66 033 00-28	Griff	1	20
6	04 23 10 044 08 90	Befestigungssatz	1	2
7	04 30 04 101 00 90	Schlauch	2	2