









33 815 861



- Ausladung 235 mm
- schwenkbarer Auslauf 360°
- optional schwenkbegrenzbar mit Schwenkbegrenzungsset 12 820 970 90
- luftangereicherter Strahl
- Durchfluss max. 8 l/min bei 3 bar Fließdruck
- bleifrei
- Dieses Produkt leistet einen Beitrag zur Erfüllung der Vorgaben von nachhaltigen Gebäudezertifizierungen, z.B. LEED®, BREEAM®, DGNB

	Dark Platinum gebürstet	33 815 861-99
	Chrom	33 815 861-00
	Platin gebürstet	33 815 861-06
	Platin	33 815 861-08
	Messing (23kt Gold)	33 815 861-09
	Dark Chrome	33 815 861-19
	Messing gebürstet (23kt Gold)	33 815 861-28
	Schwarz matt	33 815 861-33
	Champagne gebürstet (22kt Gold)	33 815 861-46
	Champagne (22kt Gold)	33 815 861-47
	Chrom gebürstet (Edelstahl-Look)	33 815 861-93

Empfohlenes Zubehör

Schwenkbegrenzungsset - 12 820 970 90



Empfohlenes Zubehör

Exzenterbetätigung mit Drehknopf - Dark Platinum gebürstet 10 712 970-99



Empfohlenes Zubehör

Spender ohne Rosette - Dark Platinum gebürstet 82 424 970-99



33 815 861

mm [inches]

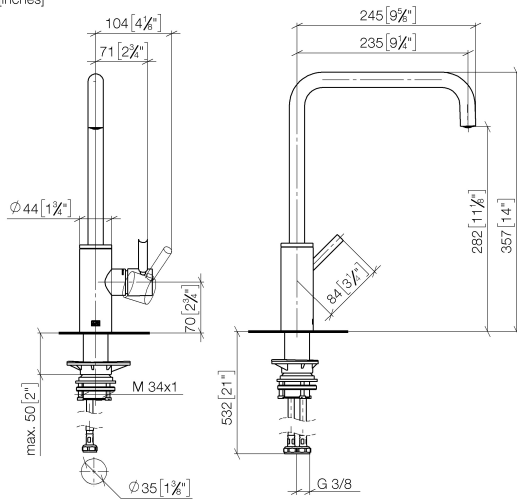

Durchflussdiagramm



Zertifikate

LGA_38642.

WRAS_240102021.

33 815 861



Ersatzteilstückliste

Nr.	Artikelnummer	Benennung	Verbaumenge	Lieferzeit
1	90 28 22 284 00-99	Auslauf	1	30
2	90 15 05 042 00 90	Kartusche	1	2
3	09 24 04 266 90	Mutter	1	2
4	90 28 30 052 00-99	Haube	1	30
5	90 20 66 033 00-99	Griff	1	30
6	04 23 10 044 08 90	Befestigungssatz	1	2
7	04 30 04 101 00 90	Schlauch	2	2