









33 870 895



- Ausladung 240 mm
- schwenkbarer Auslauf 360°
- optional schwenkbegrenzbar mit Schwenkbegrenzungsset 12 821 970 90
- Laminar- und Brausestrahl
- Armaturenhöhe 444 mm
- Höhe bis Laminarstrahlregler 240 mm
- Bohrungsdurchmesser 35 mm
- Metallbrauseschlauch 1800 mm
- Sprayface mit Antikalk-System
- Durchfluss max. 10,4 l/min bei 3 bar Fließdruck
- bleifrei
- Dieses Produkt leistet einen Beitrag zur Erfüllung der Vorgaben von nachhaltigen Gebäudezertifizierungen, z.B. LEED®, BREEAM®, DGNB

Eigensicher gegen Rückfließen.

	Messing gebürstet (23kt Gold)	33 870 895-28
	Chrom	33 870 895-00
	Platin gebürstet	33 870 895-06
	Platin	33 870 895-08
	Messing (23kt Gold)	33 870 895-09
	Dark Chrome	33 870 895-19
	Schwarz matt	33 870 895-33
	Champagne gebürstet (22kt Gold)	33 870 895-46
	Champagne (22kt Gold)	33 870 895-47
	Chrom gebürstet (Edelstahl-Look)	33 870 895-93
	Dark Platinum gebürstet	33 870 895-99

Empfohlenes Zubehör

Schwenkbegrenzungsset - 12 821 970 90



Empfohlenes Zubehör

Exzenterbetätigung mit Drehknopf - Messing gebürstet (23kt Gold) 10 712 970-28



Empfohlenes Zubehör

Spender ohne Rosette - Messing gebürstet (23kt Gold) 82 424 970-28



33 870 895

mm [inches] $\varnothing 47 [1\frac{1}{8}"]$

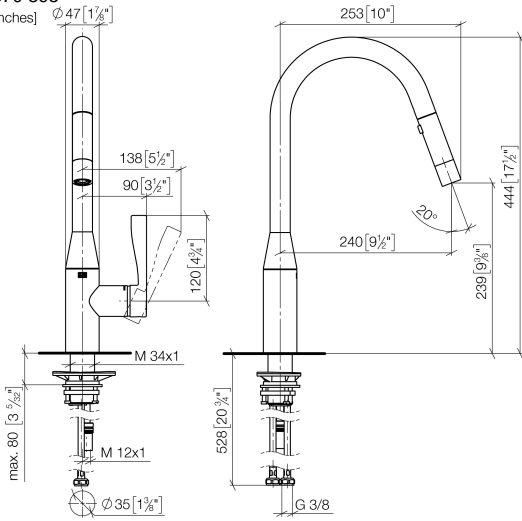

Durchflussdiagramm

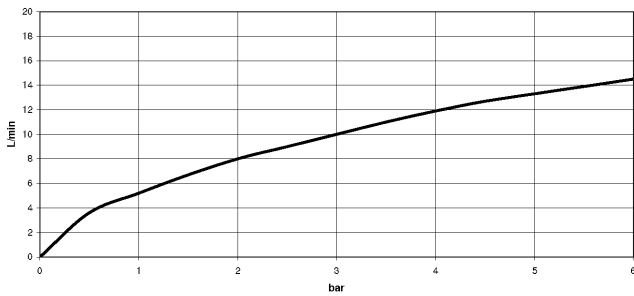

Zertifikate

Belgaqua_21-027- LGA_28657. GDV_0400314.
27_3.

33 870 895

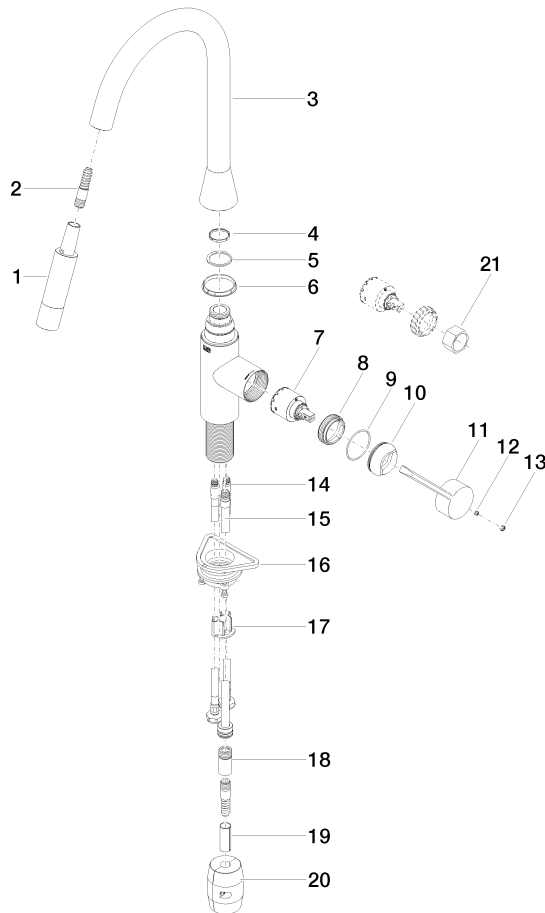

Ersatzteilstückliste

Nr.	Artikelnummer	Benennung	Verbaumenge	Lieferzeit
1	90 12 11 148 00-28	Brause	1	20
2	04 30 02 120 00-85	Schlauch	1	30
3	90 28 22 302 00-28	Auslauf	1	20
4	09 28 10 160 90	Ring	1	2
5	09 28 10 162 90	Ring	1	2
6	09 28 10 161 90	Ring	1	2
7	90 15 05 064 00 90	Kartusche	1	2
8	09 23 10 072 90	Mutter	1	60
9	09 14 10 190 90	Dichtung	1	2
10	09 28 30 030-28	Haube	1	20
11	09 20 89 020-28	Griff	1	20
12	90 31 11 063 00 90	Stift	1	2
13	90 31 20 087 00-28	Stopfen	1	20
14	04 30 04 101 00 90	Schlauch	2	2
15	04 28 20 067 00 90	Rohr	1	2
16	04 30 11 040 00 90	Befestigungssatz	1	2
17	09 20 93 056 90	Einsatz	1	2
18	90 24 03 253 00 90	Adapter	1	2
19	09 30 03 038 90	Schlauch	1	2
20	04 21 50 010 00 90	Zubehoer	1	2
21	90 30 09 031 00 90	Schlüssel	1	2