









36 060 670

- Abdeckplatte 80 x 80 mm



Passt zu: IMO, MEM, CL.1, CYO

	Chrom gebürstet	36 060 670-93
	Chrom	36 060 670-00
	Platin gebürstet	36 060 670-06
	Platin	36 060 670-08
	Dark Chrome	36 060 670-19
	Light Gold gebürstet	36 060 670-27
	Messing gebürstet (23kt Gold)	36 060 670-28
	Schwarz matt	36 060 670-33
	Champagne gebürstet (22kt Gold)	36 060 670-46
	Champagne (22kt Gold)	36 060 670-47
	Dark Platinum gebürstet	36 060 670-99

Benötigtes Zubehör



- UP-Wand-Einhandbatterie -** 35 860 970 90
- Max. Einbautiefe 95 mm
 - Min. Einbautiefe 75 mm

36 060 670

mm [inches]



Zertifikate

WRAS_2107016. LGA_29905.

36 060 670

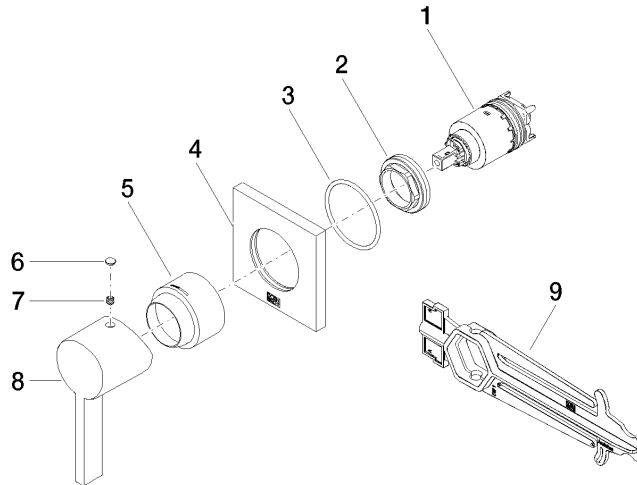

Ersatzteilstückliste

Nr.	Artikelnummer	Benennung	Verbaumenge	Lieferzeit
1	90 15 05 064 01 90	Kartusche	1	2
2	09 24 04 105 90	Mutter	1	2
3	90 14 10 049 00 90	Dichtung	1	2
4	09 27 78 048-93	Rosette	1	20
5	09 11 02 530-93	Haube	1	20
6	90 31 20 087 00-93	Stopfen	1	20
7	90 31 11 112 00 90	Stift	1	2
8	09 20 67 004-93	Griff	1	20
9	90 30 09 064 00 90	Schlüssel	1	2