

36 112 970



Passt zu: IMO, LULU, TARA, LISSÉ, VAIA, META













- Ausladung Standbrause 450 mm
- Kopfbrause: Regenstrahl
- Regenbrause Ø 220 mm
- Regenbrause mit Antikalk-System
- Durchfluss Regenbrause max. 14 l/min (bei 3 Bar)
- Höhe Armatur bis Regenbrause (Unterkante) 1010 mm
- Höhe Armatur bis Oberkante Bogen 1150 mm
- Metallbrauseschlauch 1750 mm mit integriertem Verdrehschutz
- Anschluss 1/2"
- Wandrohr mit Schieber
- Rohrdurchmesser 23,5 mm
- automatische Umstellung Standbrause/ Handbrause
- mit Leerlauf-Funktion

Dieser Artikel enthält keine Handbrause!

Eigensicher gegen Rückfließen.

Dieser Artikel enthält keine Handbrause!

Eigensicher gegen Rückfließen.

| | | |
|---|---------------------------------|---------------|
|  | Chrom | 36 112 970-00 |
|  | Platin gebürstet | 36 112 970-06 |
|  | Platin | 36 112 970-08 |
|  | Dark Chrome | 36 112 970-19 |
|  | Light Gold gebürstet | 36 112 970-27 |
|  | Messing gebürstet (23kt Gold) | 36 112 970-28 |
|  | Schwarz matt | 36 112 970-33 |
|  | Bronze gebürstet | 36 112 970-42 |
|  | Champagne gebürstet (22kt Gold) | 36 112 970-46 |
|  | Champagne (22kt Gold) | 36 112 970-47 |
|  | Chrom gebürstet | 36 112 970-93 |
|  | Dark Platinum gebürstet | 36 112 970-99 |

36 112 970

Benötigtes Zubehör

| | | |
|---|--|---------------|
|  | UP-Wandbefestigung - •Max. Einbautiefe 105 mm •Min. Einbautiefe 80 mm | 35 050 970 90 |
|---|--|---------------|

Benötigtes Zubehör

| | | |
|---|---------------------------|---------------|
|  | Handbrause - Chrom | 28 012 979-00 |
|---|---------------------------|---------------|

Benötigtes Zubehör

| | | |
|---|---------------------------|---------------|
|  | Handbrause - Chrom | 28 017 979-00 |
|---|---------------------------|---------------|

Benötigtes Zubehör

| | | |
|---|---------------------------|---------------|
|  | Handbrause - Chrom | 28 018 979-00 |
|---|---------------------------|---------------|

Benötigtes Zubehör

| | | |
|---|---|---------------|
|  | SERIENNEUTRAL Handbrause - Chrom | 28 029 979-00 |
|---|---|---------------|

Benötigtes Zubehör

| | | |
|---|---|-----------------------|
|  | SERIENNEUTRAL Handbrause - Chrom | 28 029 979-00 0010 |
|---|---|-----------------------|

Benötigtes Zubehör

| | | |
|---|---------------------------|---------------|
|  | Handbrause - Chrom | 28 016 979-00 |
|---|---------------------------|---------------|

Benötigtes Zubehör

| | | |
|---|--------------------------------------|-----------------------|
|  | Handbrause FlowReduce - Chrom | 28 016 979-00 0010 |
|---|--------------------------------------|-----------------------|

Benötigtes Zubehör

| | | |
|---|--------------------------------------|-----------------------|
|  | Handbrause FlowReduce - Chrom | 28 012 979-00 0010 |
|---|--------------------------------------|-----------------------|

Benötigtes Zubehör

| | | |
|---|--------------------------------------|-----------------------|
|  | Handbrause FlowReduce - Chrom | 28 018 979-00 0010 |
|---|--------------------------------------|-----------------------|

Benötigtes Zubehör

| | | |
|---|---|-----------------------|
|  | SERIENNEUTRAL Handbrause - Chrom | 28 027 979-00 0010 |
|---|---|-----------------------|

Benötigtes Zubehör

| | | |
|---|---|-----------------------|
|  | SERIENNEUTRAL Handbrause - Chrom | 28 025 979-00 0010 |
|---|---|-----------------------|

36 112 970

mm [inches]
1:10

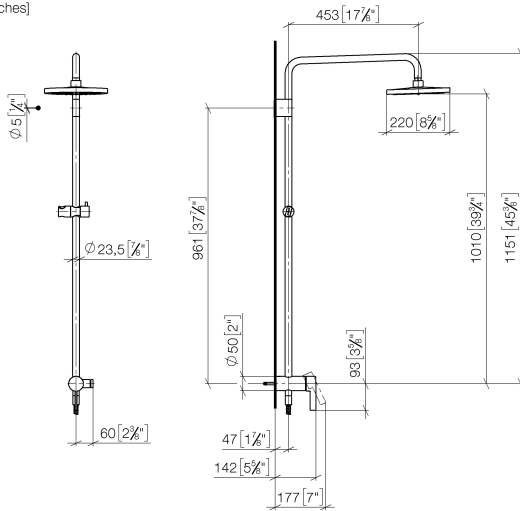

Durchflussdiagramm

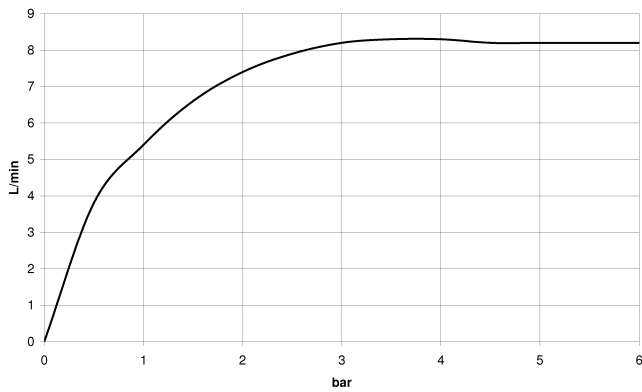

Zertifikate

DVGW_DW- 6512DN0126. Belgaqua_21-025- 27_1. WRAS_2101043. LGA_38677.

36 112 970

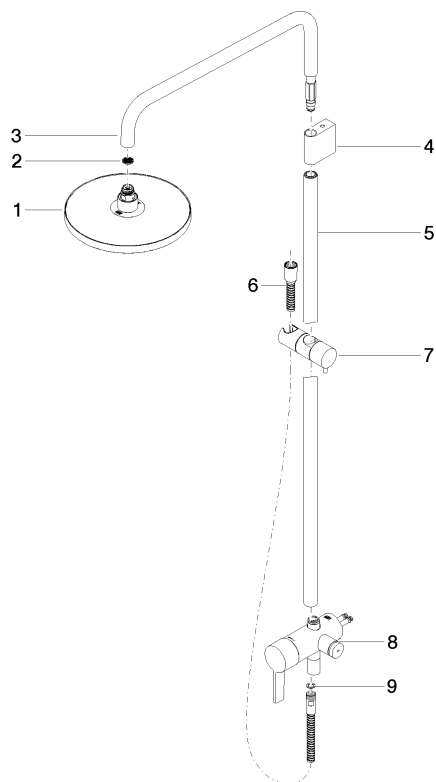

Ersatzteilstückliste

| Nr. | Artikelnummer | Benennung | Verbaumenge | Lieferzeit |
|-----|--------------------|---|-------------|------------|
| 1 | 04 12 05 092 00-00 | Brause | 1 | 10 |
| 2 | 09 23 01 039 90 | Sieb | 1 | 2 |
| 3 | 90 28 22 348 00-00 | Rohr | 1 | 10 |
| 4 | 90 17 11 149 00-00 | Halter | 1 | 10 |
| 5 | 04 28 22 349 00-00 | Rohr | 1 | 60 |
| 6 | 28 322 970-00 | Metall-Brauseschlauch 1/2" x 3/8" x 1750 mm - Chrom | 1 | 2 |
| 7 | 12 570 970-00 | Schieber - Chrom | 1 | 10 |
| 8 | 90 17 01 251 00-00 | Anschluss | 1 | 10 |
| 9 | 90 14 20 026 00 90 | Dichtung | 1 | 2 |