







36 120 660

- automatische Umstellung
- Abdeckplatte Ø 150 mm



Passt zu: TARA, META

	Platin	36 120 660-08
	Chrom	36 120 660-00
	Platin gebürstet	36 120 660-06
	Dark Chrome	36 120 660-19
	Light Gold	36 120 660-26
	Light Gold gebürstet	36 120 660-27
	Messing gebürstet (23kt Gold)	36 120 660-28
	Schwarz matt	36 120 660-33
	Bronze gebürstet	36 120 660-42
	Champagne gebürstet (22kt Gold)	36 120 660-46
	Champagne (22kt Gold)	36 120 660-47
	Chrom gebürstet	36 120 660-93
	Dark Platin gebürstet	36 120 660-99

Benötigtes Zubehör



UP-Einhandbatterie - 35 020 970 90
 •Max. Einbautiefe 105 mm
 •Min. Einbautiefe 80 mm

Empfohlenes Zubehör



xGRID Befestigungssatz für die Integration in den Trockenbau - 12 340 970 90

Benötigtes Zubehör



UP-Einhandbatterie mit Sicherungseinrichtung - 35 021 970 90
 •Max. Einbautiefe 105 mm
 •Min. Einbautiefe 80 mm

Benötigtes Zubehör



xGRID Montageschiene 555 mm - 12 360 970 90

36 120 660

mm [inches]

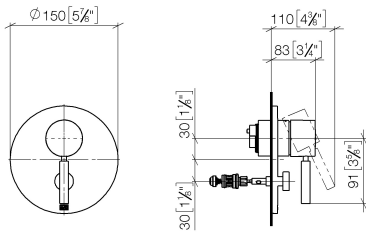

Durchflussdiagramm

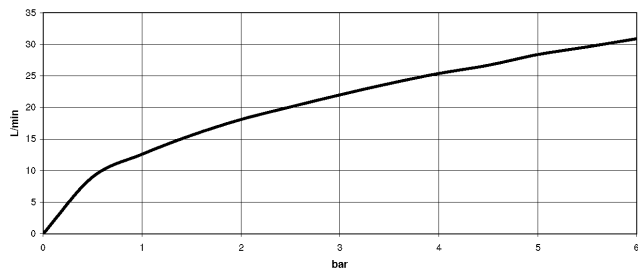

Zertifikate

DVGW_DW-
6512DN0126.

LGA_19863.

WRAS_2207012.

36 120 660

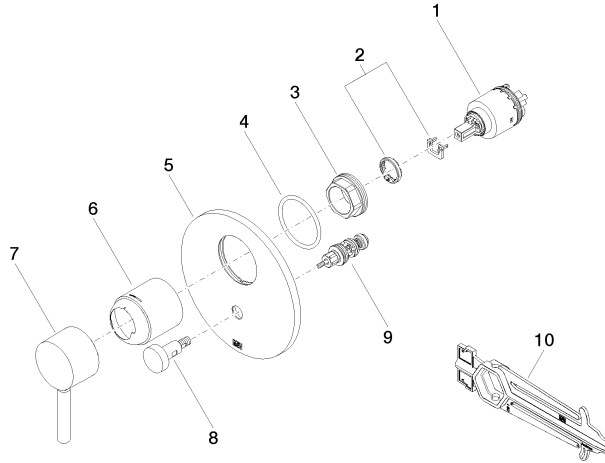

Ersatzteilstückliste

Nr.	Artikelnummer	Benennung	Verbaumenge	Lieferzeit
1	90 15 05 038 00 90	Kartusche	1	60
2	04 28 10 149 00 90	Zubehoer	1	2
3	09 24 04 448 90	Mutter	1	2
4	09 14 10 084 90	Dichtung	1	2
5	09 11 02 261-08	Platte	1	40
6	09 11 02 260-08	Huelse	1	40
7	90 20 66 004 00-08	Griff	1	40
8	90 31 09 139 00-08	Zugstange	1	40
9	90 21 34 081 00 90	Umstellung	1	2
10	90 30 09 064 00 90	Schluessel	1	2