













36 513 979



- AQUAPRESSURE FLOW, Durchfluss max. 10 l/min (bei 3 Bar)
- Strahl verstellbar
- Abdeckplatte 240 x 60 mm
- Anschluss 1/2"

Passt zu: IMO, LULU, MADISON, MEM, TARA, CL.1, LISSÉ, VAIA, META, CYO

	Chrom	36 513 979-00
	Platin gebürstet	36 513 979-06
	Platin	36 513 979-08
	Dark Chrome	36 513 979-19
	Light Gold	36 513 979-26
	Light Gold gebürstet	36 513 979-27
	Messing gebürstet (23kt Gold)	36 513 979-28
	Schwarz matt	36 513 979-33
	Bronze gebürstet	36 513 979-42
	Champagne gebürstet (22kt Gold)	36 513 979-46
	Champagne (22kt Gold)	36 513 979-47
	Chrom gebürstet	36 513 979-93
	Dark Platin gebürstet	36 513 979-99

Benötigtes Zubehör



- UP-Wandeinbaukasten -** 35 206 970 90
- Max. Einbautiefe 173 mm
 - Min. Einbautiefe 100 mm

Empfohlenes Zubehör



- xGRID Befestigungssatz für die Integration in den Trockenbau -** 12 340 970 90

Benötigtes Zubehör



- xGRID Montageschiene 555 mm -** 12 360 970 90

36 513 979

mm [inches]

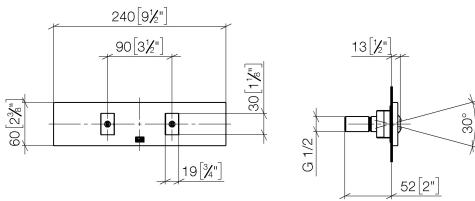

Durchflussdiagramm



Wurfweitendiagramm

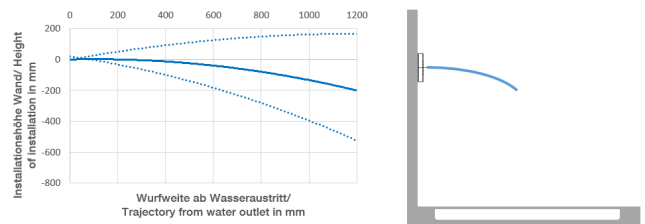

Zertifikate

LGA_29335.

WRAS_2005003.

36 513 979

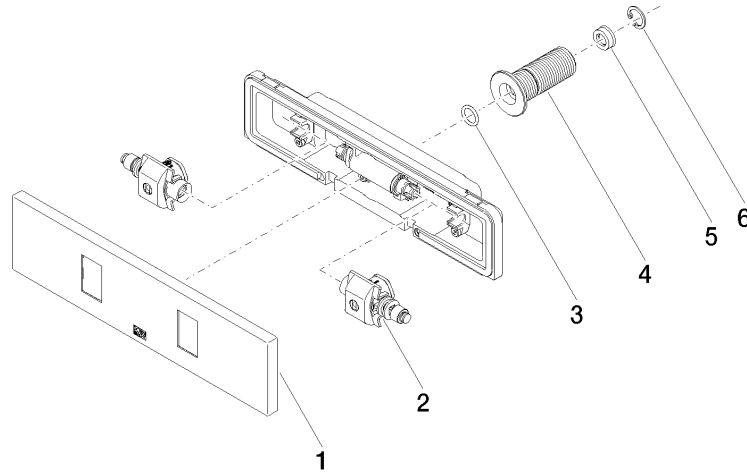

Ersatzteilstückliste

Nr.	Artikelnummer	Benennung	Verbaumenge	Lieferzeit
1	90 27 99 002 00-00	Einsatz	1	10
2	90 31 10 013 00 90	Einsatz	1	2
3	09 14 10 003 90	Dichtung	1	2
4	09 24 05 015 90	Nippel	1	2
5	09 23 01 134 90	Durchflussbegrenzer	1	2
6	09 16 01 014 90	Ring	1	2