











36 514 979



- AQUAPRESSURE FLOW, Durchfluss max. 10 l/min (bei 3 Bar)
- Strahl verstellbar
- Abdeckplatte 120 x 60 mm
- Anschluss 1/2"

Passt zu: IMO, LULU, MADISON, MEM, TARA, CL.1, LISSÉ, VAIA, META, CYO

	Light Gold gebürstet	36 514 979-27
	Chrom	36 514 979-00
	Platin gebürstet	36 514 979-06
	Platin	36 514 979-08
	Dark Chrome	36 514 979-19
	Light Gold	36 514 979-26
	Messing gebürstet (23kt Gold)	36 514 979-28
	Schwarz matt	36 514 979-33
	Bronze gebürstet	36 514 979-42
	Champagne gebürstet (22kt Gold)	36 514 979-46
	Champagne (22kt Gold)	36 514 979-47
	Chrom gebürstet	36 514 979-93
	Dark Platinum gebürstet	36 514 979-99

**Empfohlenes Zubehör**

**UP-Wandwinkel -** 35 085 970 90

- Min. Einbautiefe 90 mm
- Max. Einbautiefe 163 mm



36 514 979

mm [inches]

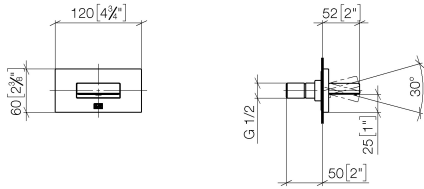

**Durchflussdiagramm**

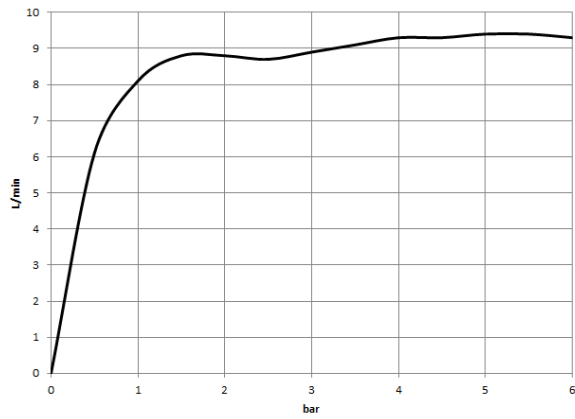

**Wurfweitendiagramm**



**Zertifikate**

LGA\_29336.

36 514 979

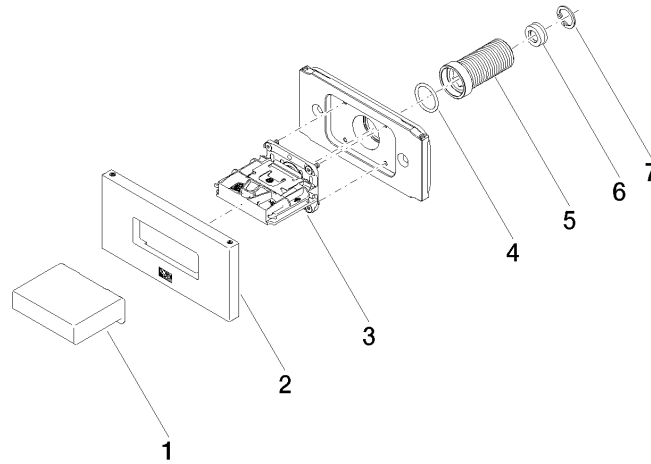

### Ersatzteilstückliste

Nr.	Artikelnummer	Benennung	Verbaumenge	Lieferzeit
1	09 17 01 230-27	Gehäuse	1	60
2	90 27 97 041 00-27	Rosette	1	30
3	90 29 03 088 00 90	Einsatz	1	2
4	90 14 10 010 00 90	Dichtung	1	2
5	09 24 04 336 90	Nippel	1	2
6	09 23 01 134 90	Durchflussbegrenzer	1	2
7	09 16 01 014 90	Ring	1	2