

**UP-Einhandbatterie mit integriertem Brauseanschluss mit Handbrausegarnitur -
Schwarz matt**

IMO

ST 050 204 8979



- Metallbrauseschlauch 1750 mm mit integriertem Verdrehenschutz
 - Handbrause: COMPACT RAIN, Durchfluss max. 10 l/min (bei 3 Bar)
 - Brausekopf Ø 130 mm
- Eigensicher gegen Rückfließen.**

Passt zu: IMO, LULU, MADISON, MEM, TARA, CL.1, LISSÉ, VAIA, META, CYO

	Schwarz matt	ST 050 204 8979-33
	Chrom	ST 050 204 8979-00
	Platin gebürstet	ST 050 204 8979-06
	Platin	ST 050 204 8979-08
	Dark Chrome	ST 050 204 8979-19
	Messing gebürstet (23kt Gold)	ST 050 204 8979-28
	Champagne gebürstet (22kt Gold)	ST 050 204 8979-46
	Champagne (22kt Gold)	ST 050 204 8979-47
	Chrom gebürstet	ST 050 204 8979-93
	Dark Platinum gebürstet	ST 050 204 8979-99

Einzelkomponenten dieses Sets

Für dieses Set benötigen Sie folgende Komponenten



1x 36 002 970-33



1x 28 017 979-33



UP-Einhandbatterie mit integriertem Brauseanschluss mit Handbrausegarnitur -
Schwarz matt

IMO

ST 050 204 8979

**UP-Einhandbatterie mit integriertem Brauseanschluss mit Handbrausegarnitur -
Schwarz matt**

IMO

ST 050 204 8979



Passt zu: IMO, LULU, MADISON, MEM,
TARA, CL.1, LISSÉ, VAIA, META, CYO

- Metallbrauseschlauch 1750 mm mit integriertem Verdrehenschutz

Dieser Artikel enthält keine Handbrause!

Eigensicher gegen Rückfließen.

Dieser Artikel enthält keine Handbrause!

Eigensicher gegen Rückfließen.

	Schwarz matt	36 002 970-33
	Chrom	36 002 970-00
	Platin gebürstet	36 002 970-06
	Platin	36 002 970-08
	Dark Chrome	36 002 970-19
	Light Gold gebürstet	36 002 970-27
	Messing gebürstet (23kt Gold)	36 002 970-28
	Bronze gebürstet	36 002 970-42
	Champagne gebürstet (22kt Gold)	36 002 970-46
	Champagne (22kt Gold)	36 002 970-47
	Chrom gebürstet	36 002 970-93
	Dark Platinum gebürstet	36 002 970-99

Benötigtes Zubehör



- UP-Wandbefestigung -**
- Max. Einbautiefe 105 mm
- Min. Einbautiefe 80 mm

35 050 970 90

Benötigtes Zubehör



- Handbrause FlowReduce -**
- Schwarz matt**

28 016 979-33
0010

Benötigtes Zubehör



- Handbrause FlowReduce -**
- Schwarz matt**

28 012 979-33
0010

Benötigtes Zubehör



- Handbrause - Schwarz matt**

28 017 979-33

Benötigtes Zubehör



- Handbrause - Schwarz matt**

28 016 979-33

Benötigtes Zubehör



- Handbrause - Schwarz matt**

28 012 979-33

Benötigtes Zubehör



- Handbrause - Schwarz matt**

28 018 979-33

Benötigtes Zubehör



- Handbrause FlowReduce -**
- Schwarz matt**

28 018 979-33
0010

**UP-Einhandbatterie mit integriertem Brauseanschluss mit Handbrausegarnitur -
Schwarz matt**

IMO

ST 050 204 8070
mm [inches]

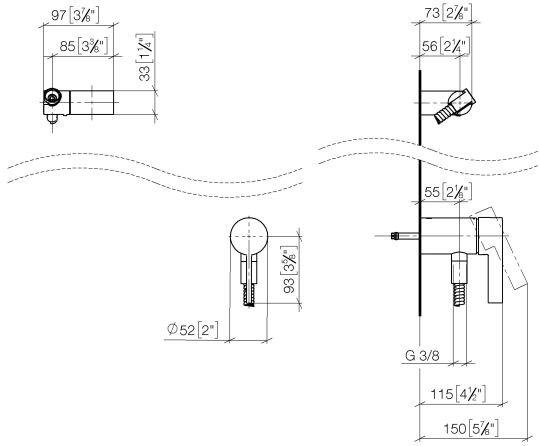

Zertifikate

Belgaqua_21-025- WRAS_2011027. LGA_29928.
27_1.

ST 050 204 8979

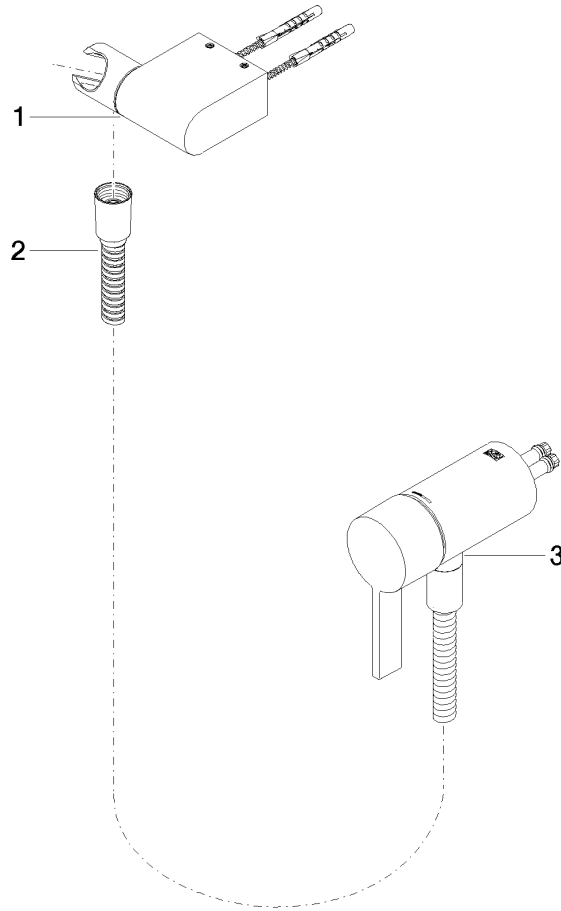

Ersatzteilstückliste

Nr.	Artikelnummer	Benennung	Verbaumenge	Lieferzeit
1	28 060 970-33	Brausehalter schwenkbar - Schwarz matt	1	30
2	28 322 970-33	Metall-Brauseschlauch 1/2" x 3/8" x 1750 mm - Schwarz matt	1	2
3	36 050 970-33	UP-Einhandbatterie mit integriertem Brauseanschluss - Schwarz matt	1	30

**UP-Einhandbatterie mit integriertem Brauseanschluss mit Handbrausegarnitur -
Schwarz matt**

IMO



























ST 050 204 8979



- COMPACT RAIN, Durchfluss max. 15 l/min (bei 3 Bar)
- mit Antikalk-System
- Brausekopf Ø 130 mm
- Anschluss 1/2"

Eigensicher gegen Rückfließen.

Passt zu: IMO, LULU, MADISON, MEM,
TARA, CL.1, LISSÉ, VAIA, META, CYO

	Schwarz matt	28 017 979-33
	Chrom	28 017 979-00 0010
	Chrom	28 017 979-00
	Platin gebürstet	28 017 979-06 0010
	Platin gebürstet	28 017 979-06
	Platin	28 017 979-08
	Platin	28 017 979-08 0010
	Dark Chrome	28 017 979-19
	Dark Chrome	28 017 979-19 0010
	Light Gold	28 017 979-26 0010
	Light Gold	28 017 979-26
	Light Gold gebürstet	28 017 979-27 0010
	Light Gold gebürstet	28 017 979-27
	Messing gebürstet (23kt Gold)	28 017 979-28
	Messing gebürstet (23kt Gold)	28 017 979-28 0010
	Schwarz matt	28 017 979-33 0010
	Bronze gebürstet	28 017 979-42 0010
	Bronze gebürstet	28 017 979-42
	Champagne gebürstet (22kt Gold)	28 017 979-46 0010
	Champagne gebürstet (22kt Gold)	28 017 979-46
	Champagne (22kt Gold)	28 017 979-47
	Champagne (22kt Gold)	28 017 979-47 0010
	Chrom gebürstet	28 017 979-93
	Chrom gebürstet	28 017 979-93 0010
	Dark Platinium gebürstet	28 017 979-99 0010
	Dark Platinium gebürstet	28 017 979-99



UP-Einhandbatterie mit integriertem Brauseanschluss mit Handbrausegarnitur -
Schwarz matt

IMO

ST 050 204 8979



UP-Einhandbatterie mit integriertem Brauseanschluss mit Handbrausegarnitur -
Schwarz matt

IMO

ST 050 204 8979



UP-Einhandbatterie mit integriertem Brauseanschluss mit Handbrausegarnitur -
Schwarz matt

IMO

ST 050 204 8979

ST 050 204 8070
mm [inches]



Durchflussdiagramm

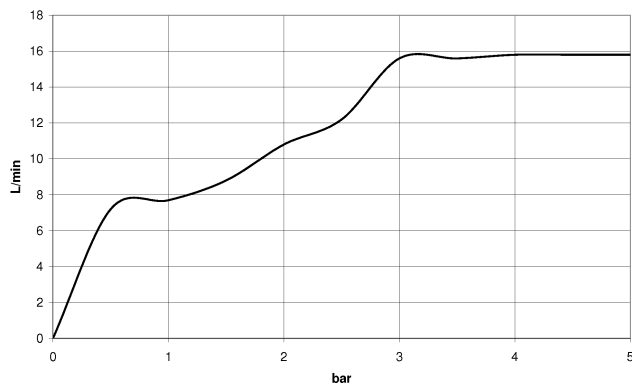

Zertifikate

DVGW_DW-
6517DN0129.

LGA_29983.

WRAS_2009011.

ST 050 204 8979
Ersatzteile für die
anderen
Oberflächenvarianten
finden Sie hier:
Chrom



Ersatzteilstückliste

Nr.	Artikelnummer	Benennung	Verbaumenge	Lieferzeit
1	09 23 01 039 90	Sieb	1	2