

ST 050 305 2979



Passt zu: IMO, LULU, TARA, LISSÉ, VAIA, META, CYO

- Ausladung Standbrause 453 mm
- Regenbrause: PURE RAIN, Durchfluss max. 7 l/min (bei 3 Bar)
- Regenbrause Ø 220 mm
- Regenbrause mit Antikalk-System
- Handbrause: COMPACT RAIN, Durchfluss max. 15 l/min (bei 3 Bar)
- Brausekopf Ø 100 mm
- Drehumstellung mit Mengenregulierung und Absperrfunktion
- Schubrosetten Ø 70 mm
- Höhe Armatur bis Regenbrause (Unterkante) 1009 mm
- Höhe Armatur bis Oberkante Bogen 1150 mm
- Stichmaß 150 mm ± 13 mm
- Metallbrauseschlauch 1750 mm mit integriertem Verdrehenschutz
- Anschluss 1/2"
- Wandrohr mit Schieber
- Rohrdurchmesser 23,5 mm

	Messing gebürstet (23kt Gold)	ST 050 305 2979-28
	Chrom	ST 050 305 2979-00
	Platin gebürstet	ST 050 305 2979-06
	Platin	ST 050 305 2979-08
	Dark Chrome	ST 050 305 2979-19
	Schwarz matt	ST 050 305 2979-33
	Champagne gebürstet (22kt Gold)	ST 050 305 2979-46
	Champagne (22kt Gold)	ST 050 305 2979-47
	Dark Platinum gebürstet	ST 050 305 2979-99

Einzelkomponenten dieses Sets

Für dieses Set benötigen Sie folgende Komponenten



1x 34 459 979-28



1x 28 015 979-28

ST 050 305 2979



Passt zu: IMO, LULU, TARA, LISSÉ, VAIA, META

- Ausladung Standbrause 453 mm
- Kopfbrause: Regenstrahl
- Regenbrause Ø 220 mm
- Regenbrause mit Antikalk-System
- Durchfluss Regenbrause max. 7 l/min (bei 3 Bar)
- Drehumstellung mit Mengenregulierung und Absperrfunktion
- Schubrosetten Ø 70 mm
- Höhe Armatur bis Regenbrause (Unterkante) 1009 mm
- Höhe Armatur bis Oberkante Bogen 1150 mm
- Stichmaß 150 mm ± 13 mm
- Metallbrauseschlauch 1750 mm mit integriertem Verdrehschutz
- Anschluss 1/2"
- Wandrohr mit Schieber
- Rohrdurchmesser 23,5 mm
- mit Leerlauf-Funktion
- Dieses Produkt leistet einen Beitrag zur Erfüllung der Vorgaben von nachhaltigen Gebäudezertifizierungen, z.B. LEED®, BREEAM®, DGNB

Dieser Artikel enthält keine Handbrause!

Eigensicher gegen Rückfließen.

	Messing gebürstet (23kt Gold)	34 459 979-28
	Chrom	34 459 979-00
	Platin gebürstet	34 459 979-06
	Platin	34 459 979-08
	Dark Chrome	34 459 979-19
	Light Gold	34 459 979-26
	Light Gold gebürstet	34 459 979-27
	Schwarz matt	34 459 979-33
	Bronze gebürstet	34 459 979-42
	Champagne gebürstet (22kt Gold)	34 459 979-46
	Champagne (22kt Gold)	34 459 979-47
	Chrom gebürstet	34 459 979-93
	Dark Platinum gebürstet	34 459 979-99

Benötigtes Zubehör

	Handbrause - Messing gebürstet (23kt Gold)	28 018 979-28
--	---	---------------

Benötigtes Zubehör

	Handbrause - Messing gebürstet (23kt Gold)	28 017 979-28
--	---	---------------

Benötigtes Zubehör

	Handbrause FlowReduce - Messing gebürstet (23kt Gold)	28 012 979-28 0010
--	--	--------------------

Benötigtes Zubehör

	Handbrause FlowReduce - Messing gebürstet (23kt Gold)	28 018 979-28 0010
--	--	--------------------

Benötigtes Zubehör

	Handbrause - Messing gebürstet (23kt Gold)	28 016 979-28
--	---	---------------

Benötigtes Zubehör

	Handbrause - Messing gebürstet (23kt Gold)	28 012 979-28
--	---	---------------

Benötigtes Zubehör

	Handbrause FlowReduce - Messing gebürstet (23kt Gold)	28 016 979-28 0010
--	--	--------------------

ST 050 305 2979

mm [inches]
1:10

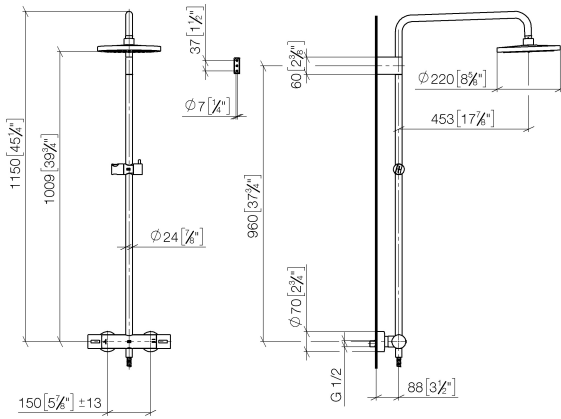

Durchflussdiagramm

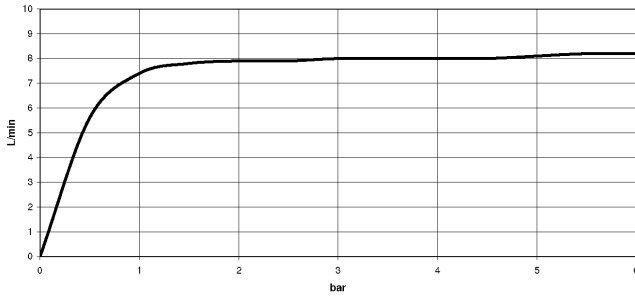

Zertifikate

DVGW_DW-6509DN0123. Belgaqua_21-032-27_5. WRAS_2204013. LGA_38737.

ST 050 305 2979

Ersatzteile für die
anderen
Oberflächenvarianten
finden Sie hier:
Chrom

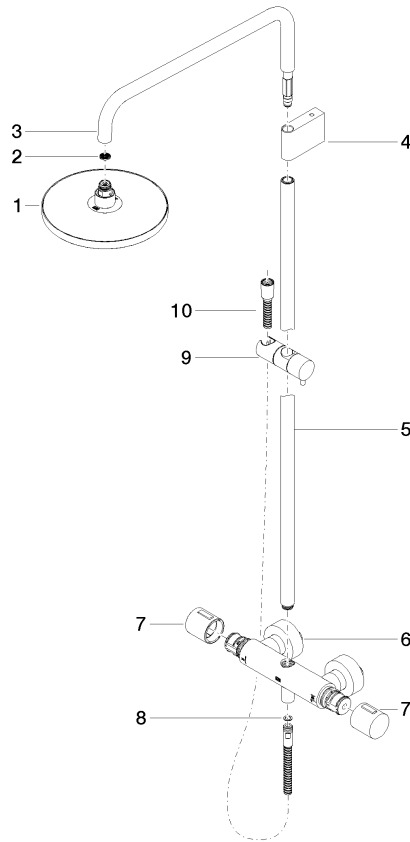

Ersatzteilstückliste

Nr.	Artikelnummer	Benennung	Verbaumenge	Lieferzeit
1	90 12 05 092 20-28	Brause	1	20
2	09 23 01 039 90	Sieb	1	2
3	90 28 22 348 00-28	Rohr	1	20
4	90 17 11 150 00-28	Halter	1	20
5	90 28 22 349 00-28	Rohr	1	20
6	04 17 01 250 00-28	Anschluss	1	20
7	90 17 33 015 00-28	Griff	2	20
8	90 14 20 026 00 90	Dichtung	1	2
9	12 570 970-28	Schieber - Messing gebürstet (23kt Gold)	1	20
10	28 322 970-28	Metall-Brauseschlauch 1/2" x 3/8" x 1750 mm - Messing gebürstet (23kt Gold)	1	20

























ST 050 305 2979



- COMPACT RAIN, Durchfluss max. 15 l/min (bei 3 Bar)
- mit Antikalk-System
- Brausekopf Ø 100 mm
- Anschluss 1/2"

Eigensicher gegen Rückfließen.

Passt zu: IMO, LULU, MADISON, MEM, TARA, CL.1, LISSÉ, VAIA, META, CYO

	Messing gebürstet (23kt Gold)	28 015 979-28
	Chrom	28 015 979-00
	Chrom	28 015 979-00 0010
	Platin gebürstet	28 015 979-06
	Platin gebürstet	28 015 979-06 0010
	Platin	28 015 979-08
	Platin	28 015 979-08 0010
	Dark Chrome	28 015 979-19
	Dark Chrome	28 015 979-19 0010
	Light Gold	28 015 979-26 0010
	Light Gold	28 015 979-26
	Light Gold gebürstet	28 015 979-27
	Light Gold gebürstet	28 015 979-27 0010
	Messing gebürstet (23kt Gold)	28 015 979-28 0010
	Schwarz matt	28 015 979-33
	Schwarz matt	28 015 979-33 0010
	Bronze gebürstet	28 015 979-42
	Bronze gebürstet	28 015 979-42 0010
	Champagne gebürstet (22kt Gold)	28 015 979-46 0010
	Champagne gebürstet (22kt Gold)	28 015 979-46
	Champagne (22kt Gold)	28 015 979-47
	Champagne (22kt Gold)	28 015 979-47 0010
	Chrom gebürstet	28 015 979-93
	Chrom gebürstet	28 015 979-93 0010
	Dark Platinum gebürstet	28 015 979-99
	Dark Platinum gebürstet	28 015 979-99 0010

ST 050 305 2979

mm [inches]

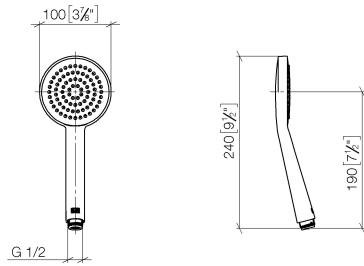

Durchflussdiagramm

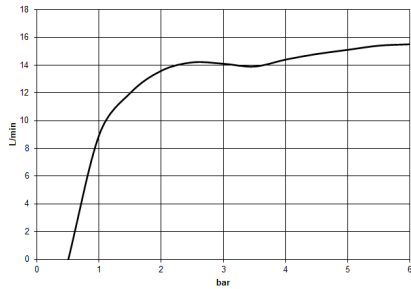

Zertifikate

DVGW_DW-6517DN0129. WRAS_2009011. LGA_29981.

ST 050 305 2979

Ersatzteile für die
anderen
Oberflächenvarianten
finden Sie hier:
Chrom

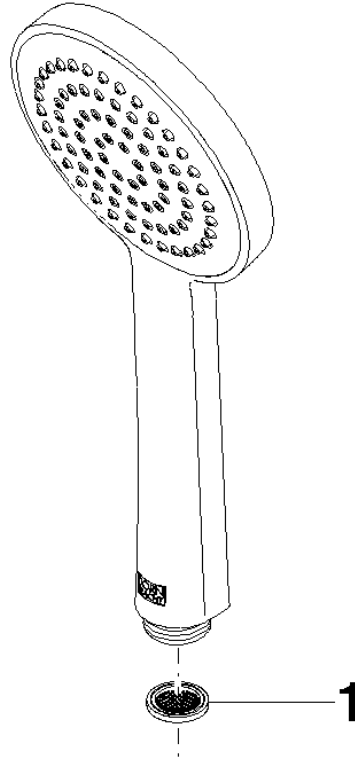

Ersatzteilstückliste

Nr.	Artikelnummer	Benennung	Verbaumenge	Lieferzeit
1	09 23 01 039 90	Sieb	1	2