

ST 050 306 6979



Passt zu: IMO, LULU, TARA, LISSÉ, VAIA, META, CYO

- Ausladung Standbrause 453 mm
- Regenbrause: PURE RAIN, Durchfluss max. 14 l/min (bei 3 Bar)
- Funktion ab: 10 l/min
- Regenbrause Ø 300 mm
- Regenbrause mit Antikalk-System
- Handbrause: Dreifach bzw. fünffach verstellbar: COMPACT RAIN, COMPACT SOFT FLOW, COMPACT AQUAPRESSURE FLOW, Durchfluss max. 15 l/min (bei 3 Bar)
- Brausekopf Ø 100 mm
- Drehumstellung mit Mengenregulierung und Absperrfunktion
- Schubrosetten Ø 70 mm
- Höhe Armatur bis Regenbrause (Unterkante) 1009 mm
- Höhe Armatur bis Oberkante Bogen 1150 mm
- Stichmaß 150 mm ± 13 mm
- Metallbrauseschlauch 1750 mm mit integriertem Verdrehenschutz
- Anschluss 1/2"
- Wandrohr mit Schieber
- Rohrdurchmesser 23,5 mm

	Schwarz matt	ST 050 306 6979-33
	Chrom	ST 050 306 6979-00
	Platin gebürstet	ST 050 306 6979-06
	Platin	ST 050 306 6979-08
	Dark Chrome	ST 050 306 6979-19
	Light Gold	ST 050 306 6979-26
	Light Gold gebürstet	ST 050 306 6979-27
	Messing gebürstet (23kt Gold)	ST 050 306 6979-28
	Bronze gebürstet	ST 050 306 6979-42
	Champagne gebürstet (22kt Gold)	ST 050 306 6979-46
	Champagne (22kt Gold)	ST 050 306 6979-47
	Chrom gebürstet	ST 050 306 6979-93
	Dark Platinum gebürstet	ST 050 306 6979-99

Einzelkomponenten dieses Sets

Für dieses Set benötigen Sie folgende Komponenten



1x 34 460 979-33



1x 28 018 979-33

ST 050 306 6979



Passt zu: IMO, LULU, TARA, LISSÉ, VAIA, META

- Ausladung Standbrause 453 mm
- Kopfbrause: Regenstrahl
- Regenbrause Ø 300 mm
- Regenbrause mit Antikalk-System
- Durchfluss Regenbrause max. 14 l/min (bei 3 Bar)
- Funktion ab: 10 l/min
- Drehumstellung mit Mengenregulierung und Absperrfunktion
- Schubrosetten Ø 70 mm
- Höhe Armatur bis Regenbrause (Unterkante) 1009 mm
- Höhe Armatur bis Oberkante Bogen 1150 mm
- Stichmaß 150 mm ± 13 mm
- Metallbrauseschlauch 1750 mm mit integriertem Verdrehschutz
- Anschluss 1/2"
- Wandrohr mit Schieber
- Rohrdurchmesser 23,5 mm
- mit Leerlauf-Funktion

Dieser Artikel enthält keine Handbrause!

Eigensicher gegen Rückfließen.

	Schwarz matt	34 460 979-33
	Chrom	34 460 979-00
	Platin gebürstet	34 460 979-06
	Platin	34 460 979-08
	Dark Chrome	34 460 979-19
	Dark Chrome	34 460 979-19 0010
	Light Gold	34 460 979-26
	Light Gold gebürstet	34 460 979-27
	Messing gebürstet (23kt Gold)	34 460 979-28
	Bronze gebürstet	34 460 979-42
	Champagne gebürstet (22kt Gold)	34 460 979-46
	Champagne (22kt Gold)	34 460 979-47
	Chrom gebürstet	34 460 979-93
	Dark Platinum gebürstet	34 460 979-99

ST 050 306 6979

Benötigtes Zubehör

	Handbrause FlowReduce - Schwarz matt	28 016 979-33 0010
---	---	-----------------------

Benötigtes Zubehör

	Handbrause FlowReduce - Schwarz matt	28 012 979-33 0010
---	---	-----------------------

Benötigtes Zubehör

	Handbrause - Schwarz matt	28 017 979-33
---	----------------------------------	---------------

Benötigtes Zubehör

	Handbrause - Schwarz matt	28 016 979-33
---	----------------------------------	---------------

Benötigtes Zubehör

	Handbrause - Schwarz matt	28 012 979-33
---	----------------------------------	---------------

Benötigtes Zubehör

	Handbrause - Schwarz matt	28 018 979-33
---	----------------------------------	---------------

Benötigtes Zubehör

	Handbrause FlowReduce - Schwarz matt	28 018 979-33 0010
---	---	-----------------------

Benötigtes Zubehör

	SERIENNEUTRAL Handbrause - Schwarz matt	28 029 979-33 0010
---	--	-----------------------

Benötigtes Zubehör

	SERIENNEUTRAL Handbrause - Schwarz matt	28 027 979-33 0010
---	--	-----------------------

Benötigtes Zubehör

	SERIENNEUTRAL Handbrause - Schwarz matt	28 029 979-33
---	--	---------------

Benötigtes Zubehör

	SERIENNEUTRAL Handbrause - Schwarz matt	28 025 979-33 0010
---	--	-----------------------

ST 050 306 6979

mm [inches]
1:10

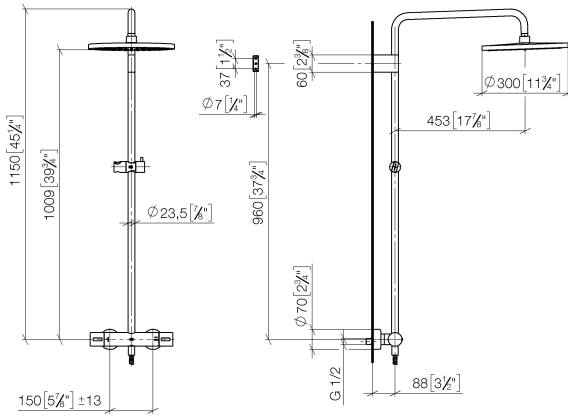

Durchflussdiagramm

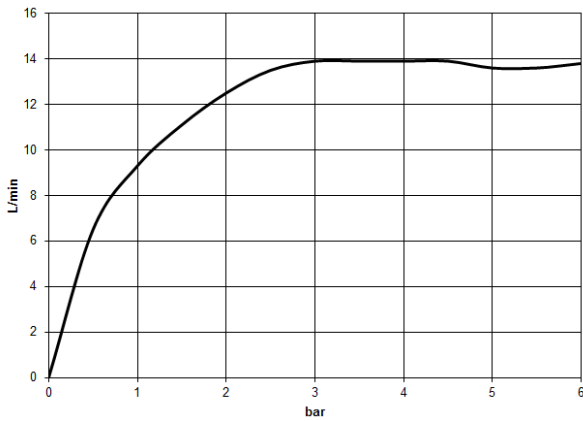

Zertifikate

DVGW_DW-6509DN0123. Belgaqua_21-032-27_5. WRAS_2204013. LGA_38736.

ST 050 306 6979

Ersatzteile für die
anderen
Oberflächenvarianten
finden Sie hier:
Chrom

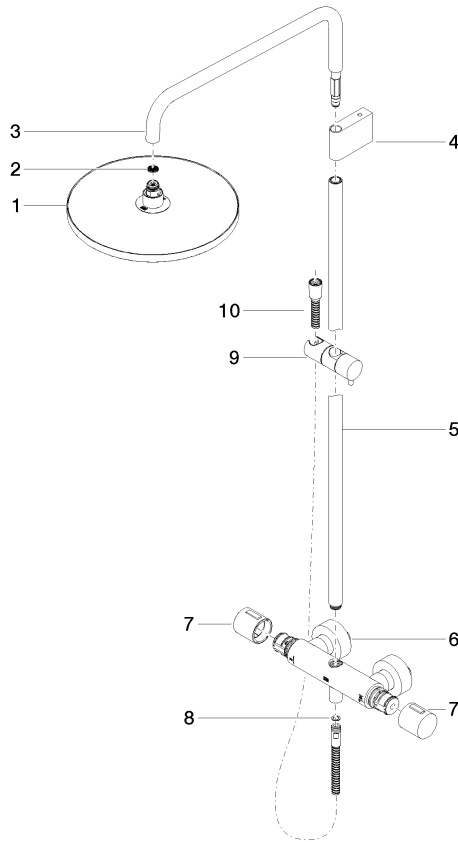

Ersatzteilstückliste

Nr.	Artikelnummer	Benennung	Verbaumenge	Lieferzeit
1	04 12 05 091 00-33	Brause	1	30
2	09 23 01 039 90	Sieb	1	2
3	90 28 22 348 00-33	Rohr	1	30
4	90 17 11 150 00-33	Halter	1	30
5	90 28 22 349 00-33	Rohr	1	30
6	04 17 01 250 00-33	Anschluss	1	30
7	90 17 33 015 00-33	Griff	2	30
8	90 14 20 026 00 90	Dichtung	1	2
9	12 570 970-33	Schieber - Schwarz matt	1	30
10	28 322 970-33	Metall-Brauseschlauch 1/2" x 3/8" x 1750 mm - Schwarz matt	1	2





























ST 050 306 6979



Passt zu: IMO, LULU, MADISON, MEM, TARA, CL.1, LISSÉ, VAIA, META, CYO

- Dreifach bzw. fünffach verstellbar: COMPACT RAIN, COMPACT SOFT FLOW, COMPACT AQUAPRESSURE FLOW, Durchfluss max. 15 l/min (bei 3 Bar)
- mit Antikalk-System
- Brausekopf Ø 100 mm
- Anschluss 1/2"
- Funktion ab: 7 l/min

Eigensicher gegen Rückfließen.

	Schwarz matt	28 018 979-33
	Chrom	28 018 979-00
	Chrom	28 018 979-00 0010
	Platin gebürstet	28 018 979-06
	Platin gebürstet	28 018 979-06 0010
	Platin	28 018 979-08
	Platin	28 018 979-08 0010
	Dark Brass matt	28 018 979-16 0010
	Dark Bronze matt	28 018 979-17 0010
	Dark Chrome	28 018 979-19
	Dark Chrome	28 018 979-19 0010
	Light Gold	28 018 979-26 0010
	Light Gold	28 018 979-26
	Light Gold gebürstet	28 018 979-27 0010
	Light Gold gebürstet	28 018 979-27
	Messing gebürstet (23kt Gold)	28 018 979-28
	Messing gebürstet (23kt Gold)	28 018 979-28 0010
	Schwarz matt	28 018 979-33 0010
	Bronze gebürstet	28 018 979-42
	Bronze gebürstet	28 018 979-42 0010
	Champagne gebürstet (22kt Gold)	28 018 979-46
	Champagne gebürstet (22kt Gold)	28 018 979-46 0010
	Champagne (22kt Gold)	28 018 979-47
	Champagne (22kt Gold)	28 018 979-47 0010
	Chrom gebürstet	28 018 979-93
	Chrom gebürstet	28 018 979-93 0010
	Dark Platinum gebürstet	28 018 979-99
	Dark Platinum gebürstet	28 018 979-99 0010

ST 050 306 6979

mm [inches]

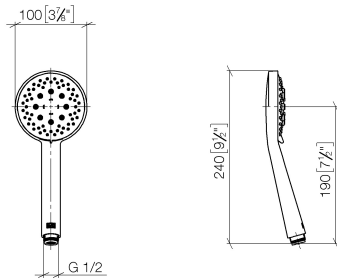

Durchflussdiagramm

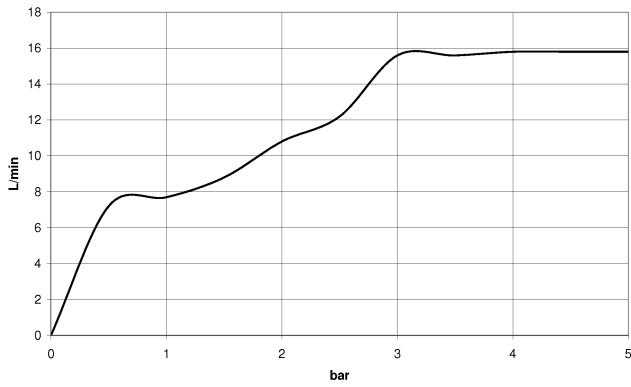

Zertifikate

LGA_29984.

DVGW_DW-
6517DN0129.

WRAS_2210003.

ST 050 306 6979

Ersatzteile für die
anderen
Oberflächenvarianten
finden Sie hier:
Chrom

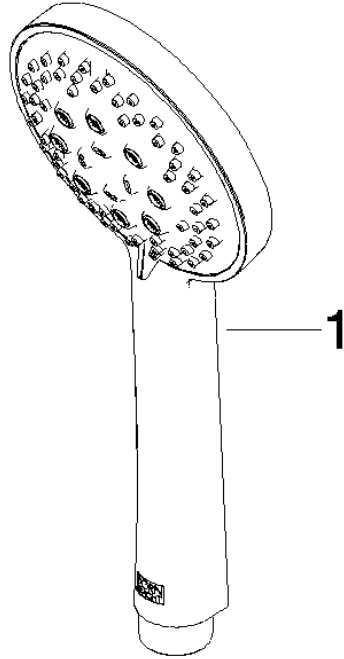

Ersatzteilstückliste

Nr.	Artikelnummer	Benennung	Verbaumenge	Lieferzeit
1	09 23 01 039 90	Sieb	1	2