











ST 110 202 6809



- Ausladung 241 mm
- schwenkbarer Auslauf 360°
- luftangereicherter Strahl und Brausestrahl
- gewebeumflochtener Brauseschlauch 1500 mm
- automatischer Umschalter Auslauf/Brause
- Sprayface mit Antikalk-System
- Durchfluss max. 7 l/min bei 3 bar Fließdruck
- bleifrei
- Dieses Produkt leistet einen Beitrag zur Erfüllung der Vorgaben von nachhaltigen Gebäudezertifizierungen, z.B. LEED®, BREEAM®, DGNB

	Dark Chrome	ST 110 202 6809-19
	Chrom	ST 110 202 6809-00
	Platin gebürstet	ST 110 202 6809-06
	Platin	ST 110 202 6809-08
	Messing (23kt Gold)	ST 110 202 6809-09
	Messing gebürstet (23kt Gold)	ST 110 202 6809-28
	Schwarz matt	ST 110 202 6809-33
	Champagne gebürstet (22kt Gold)	ST 110 202 6809-46
	Champagne (22kt Gold)	ST 110 202 6809-47
	Chrom gebürstet (Edelstahl-Look)	ST 110 202 6809-93
	Dark Platinum gebürstet	ST 110 202 6809-99

### Einzelkomponenten dieses Sets

Für dieses Set benötigen Sie folgende Komponenten



1x 19 815 809-19









1x 27 731 809-19



ST 110 202 6809



- Ausladung 241 mm
- schwenkbarer Auslauf 360°
- luftangereicherter Strahl
- Durchfluss max. 7 l/min bei 3 bar Fließdruck
- bleifrei
- Dieses Produkt leistet einen Beitrag zur Erfüllung der Vorgaben von nachhaltigen Gebäudezertifizierungen, z.B. LEED®, BREEAM®, DGNB

	Dark Chrome	19 815 809-19
	Chrom	19 815 809-00
	Platin gebürstet	19 815 809-06
	Platin	19 815 809-08
	Messing (23kt Gold)	19 815 809-09
	Messing gebürstet (23kt Gold)	19 815 809-28
	Schwarz matt	19 815 809-33
	Champagne gebürstet (22kt Gold)	19 815 809-46
	Champagne (22kt Gold)	19 815 809-47
	Chrom gebürstet (Edelstahl-Look)	19 815 809-93
	Dark Platinum gebürstet	19 815 809-99

**Empfohlenes Zubehör**

**VAIA Spender mit Rosette - Dark Chrome** 82 434 809-19



ST 110 202 6809

mm [inches]  
1:5

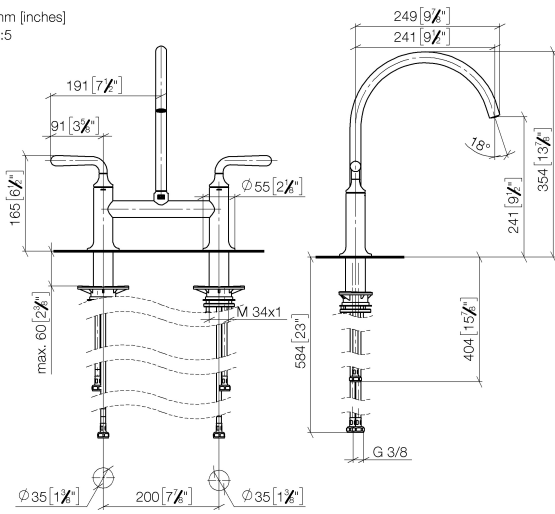

### Durchflussdiagramm

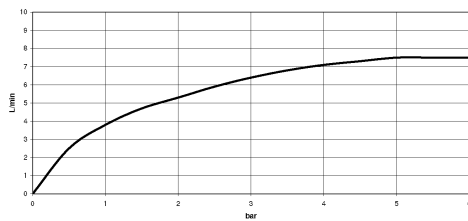

### Zertifikate

LGA\_38632.

ST 110 202 6809

Ersatzteile für die  
anderen  
Oberflächenvarianten  
finden Sie hier:  
Chrom

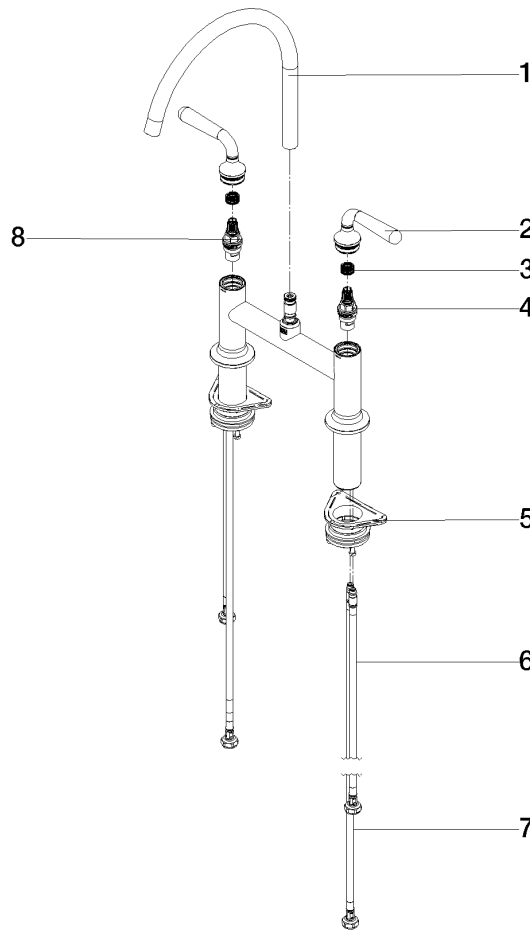

### Ersatzteilstückliste

Nr.	Artikelnummer	Benennung	Verbaumenge	Lieferzeit
1	90 28 22 396 00-19	Auslauf	1	-
Ersatzteil nicht mehr bestellbar, bitte bestellen Sie den Nachfolgeartikel				
2	90 20 80 057 00-19	Griff	2	-
Ersatzteil nicht mehr bestellbar, bitte bestellen Sie den Nachfolgeartikel				
3	90 12 12 232 00 90	Rastbuchse	2	2
4	90 90 03 130 00 90	Oberteil	1	2
5	04 30 11 040 00 90	Befestigungssatz	2	2
6	04 30 04 100 00 90	Schlauch	2	2
7	04 30 04 101 00 90	Schlauch	2	2
8	90 90 03 131 00 90	Oberteil	1	2

ST 110 202 6809



- mit runder Rosette
- Brausestrahl
- automatischer Umschalter Auslauf/Brause
- Armaturenhöhe 202 mm
- Bohrungsdurchmesser Spülbrause 32 mm
- gewebeumflochtener Brauseschlauch 1500 mm
- Sprayface mit Antikalk-System
- bleifrei

Nur kombinierbar mit 33810809, 33826809, 19815809, 19825809.

Eigensicher gegen Rückfließen.

Bedienteil frei positionierbar.

	Dark Chrome	27 731 809-19
	Chrom	27 731 809-00
	Platin gebürstet	27 731 809-06
	Platin	27 731 809-08
	Messing (23kt Gold)	27 731 809-09
	Messing gebürstet (23kt Gold)	27 731 809-28
	Schwarz matt	27 731 809-33
	Champagne gebürstet (22kt Gold)	27 731 809-46
	Champagne (22kt Gold)	27 731 809-47
	Chrom gebürstet (Edelstahl-Look)	27 731 809-93
	Dark Platinum gebürstet	27 731 809-99



ST 110 202 6809

mm [inches]



Zertifikate

Belgaqua\_24-005-  
27\_3.







