

Deck valve clockwise closing hot - Brushed Platinum







CL.1

20 000 715



- hole diameter 32 mm
- rosette 60 x 60 mm
- with hot marking

Fits: CL.1, CYO

	Brushed Platinum	20 000 715-06
	Chrome	20 000 715-00
	Dark Chrome	20 000 715-19
	Brushed Durabronze (23kt Gold)	20 000 715-28
	Brushed Champagne (22kt Gold)	20 000 715-46
	Champagne (22kt Gold)	20 000 715-47
	Brushed Dark Platinum	20 000 715-99

20 000 715

mm [inches]

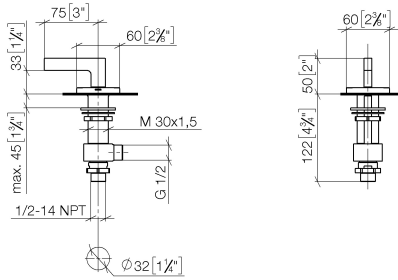

Flow rate chart

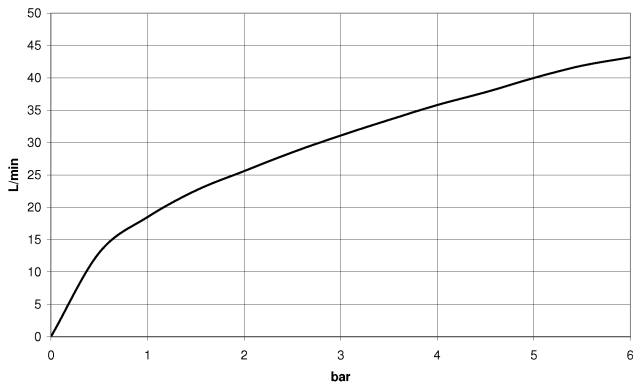

Codes & Standards

ASME A112.18.1

cUPC

DIN 4109

ISO 3822

Ü-Zeichen



Deck valve clockwise closing hot - Brushed Platinum

CL.1

20 000 715

Certificates

IAPMO_4976

LGA_28

20 000 715

Product version from 6/1/2015

Parts for other finishes can be found here: [Chrome](#)

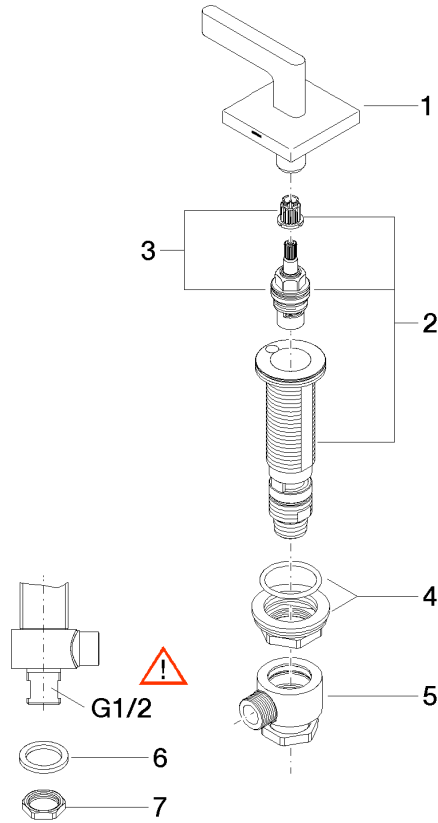



Deck valve clockwise closing hot - Brushed Platinum

CL.1

20 000 715

Spare parts list

Product version from 6/1/2015

No.	Item Number	Name	Quantity used	Delivery time
	90 20 70 057 00-06	handle (hot)	7	10