









20 713 809



- 168mm projection
- pivotable spout 360°
- circular, air-enriched flow
- height of mixer 280 mm
- height up to aerator 191 mm
- hole diameter valve 32 mm
- hole diameter spout 35 mm
- rosette Ø 60 mm
- max. flow 5.7 l/min
- lead-free
- This product can help a building meet the requirements of Green Building Rating Systems, e.g. LEED®, BREEAM®, DGNB
- WRAS 2312068

Only suitable for basins with an overflow.

	Brushed Dark Platinum	20 713 809-99
	Chrome	20 713 809-00
	Brushed Platinum	20 713 809-06
	Platinum	20 713 809-08
	Dark Chrome	20 713 809-19
	Brushed Durabronze (23kt Gold)	20 713 809-28
	Brushed Bronze	20 713 809-42
	Brushed Champagne (22kt Gold)	20 713 809-46
	Champagne (22kt Gold)	20 713 809-47

20 713 809

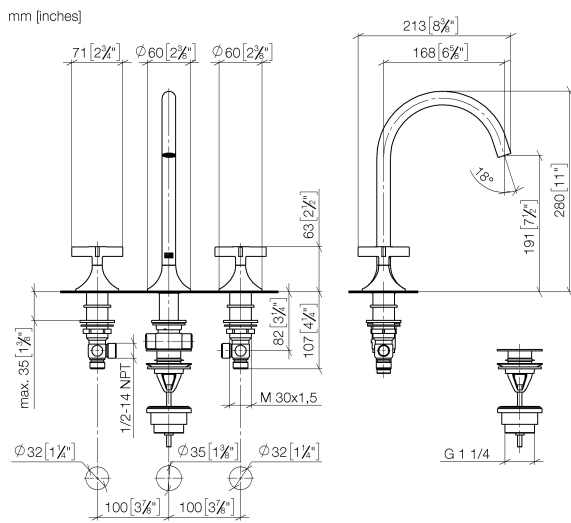

Flow rate chart

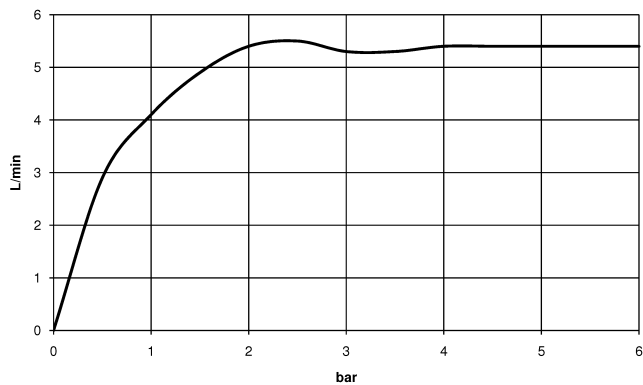

Certificates

LGA_29292.

ACS_20 ACC LY 737. GDV_0400287.

WRAS_2312068.

20 713 809

Parts for other finishes can be found here: [Chrome](#)

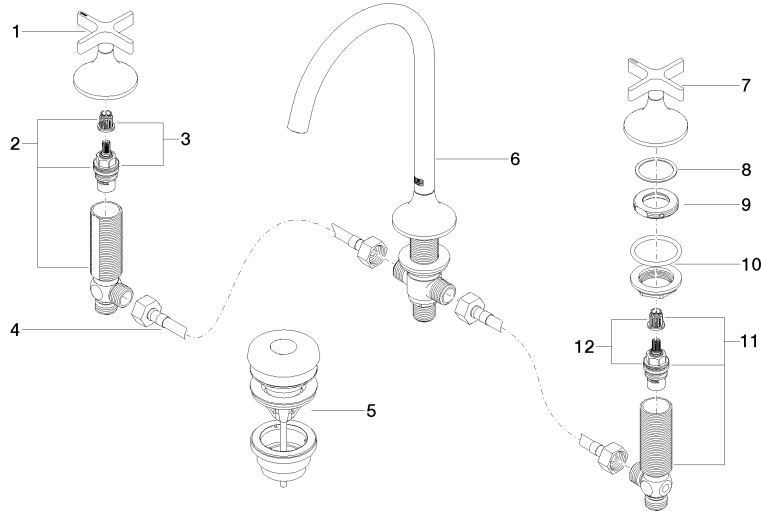

Spare parts list

No.	Item Number	Name	Quantity used	Delivery time
1	90 20 80 011 00-99	handle (hot)	1	30
2	04 17 11 055 51 90	side panel	1	2
3	90 90 03 151 00 90	top	1	2
4	04 30 04 096 00 90	hose	2	2
5	10 125 970-99	Basin Waste with push fastening 1 1/4" - Brushed Dark Platinum	1	2
6	13 716 809-99	VAIA Deck-mounted basin spout without pop-up waste - Brushed Dark Platinum	1	30
7	90 20 80 010 00-99	handle (cold)	1	30
8	09 28 10 003 90	ring	2	2
9	09 24 01 028 90	ring	2	2
10	04 23 10 032 46 90	fixing set	2	2
11	04 17 11 055 50 90	side panel	1	2
12	90 90 03 150 00 90	top	1	2